

Overview

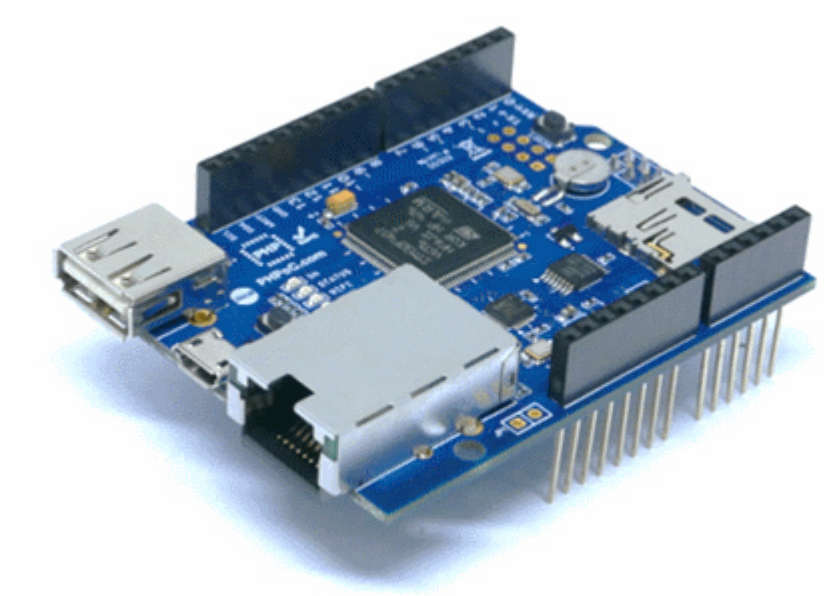

Introduction

PHPoC Shield for Arduino connects Arduino to Ethernet or Wi-Fi networks. Attach this board over Arduino and connect a LAN cable. After a simple network setup, Arduino is connected to the Internet. To use a wireless LAN, connect to a WIFI dongle.

The network function of this shield is based on the TCP/IP stack using PHPoC interpreter. The shield can be easily accessed by Phpoc Library. Phpoc Library is very similar to the usage of Arduino Ethernet library or WIFI library. Therefore, source codes using existing Ethernet library or WIFI library can be used immediately after modifying just few lines. It will surely reduce trials and errors of users with the previous experience using Ethernet shield or WIFI shield.

Furthermore, Phpoc Library has a wider range of applications since it supports a variety of API(e.g. SSL, SSH, TELNET, Web socket, ESMTTP and so on) absent from the existing libraries.

Key Features

- Mounted on Arduino board (Compatible boards: Uno & Mega)
- Power: DC 5V (Supplied from Arduino boards)
- Network controller: PHPoC interpreter
- Ethernet: 10/100Mb
- Wireless LAN: IEEE802.11b/g
- WLAN security: WPA-PSK/Enterprise
- Save time information (RTC - Battery Backup)
- Web settings (Smartphone or PC)
- Embedded web applications: Serial monitor, remote control (push), remote control (slide)
- SPI communication with Arduino board
- Support IPv6

Protocol Stack

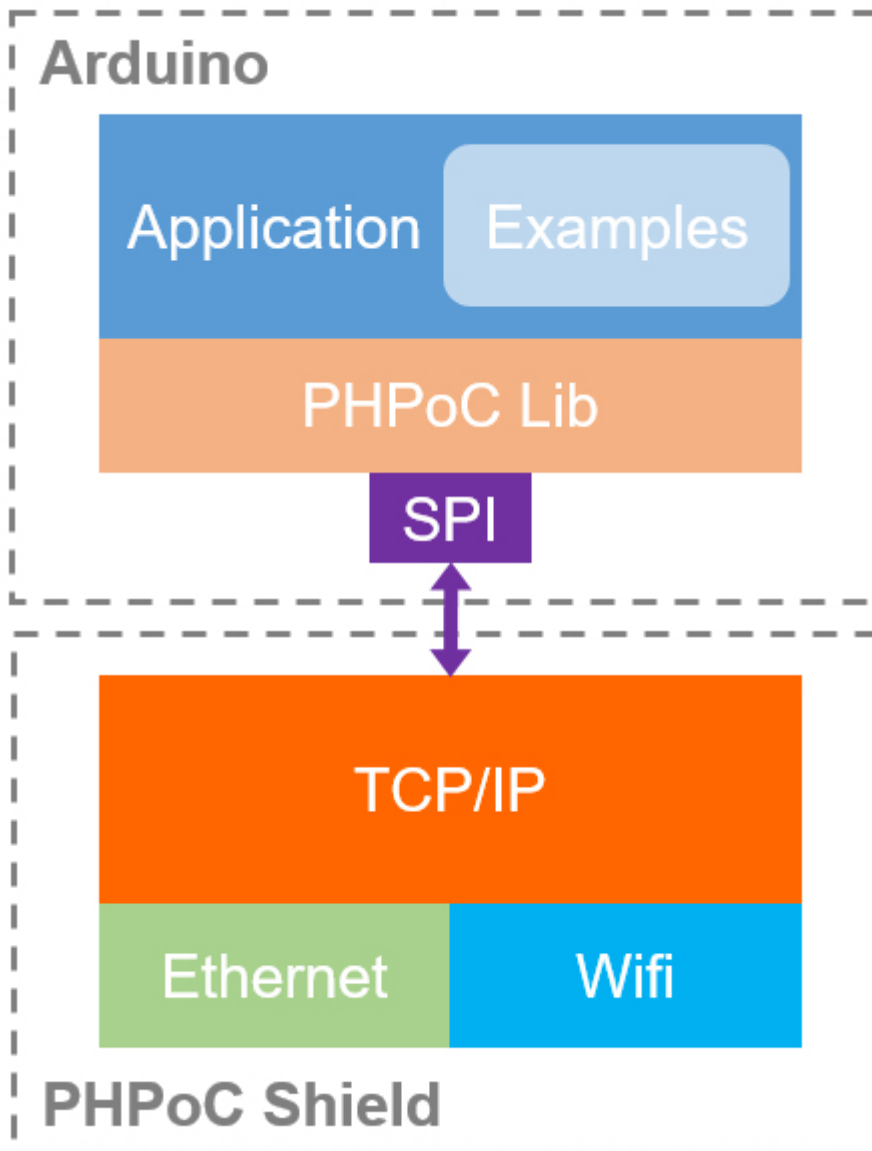

Hardware Specifications

Block Diagram

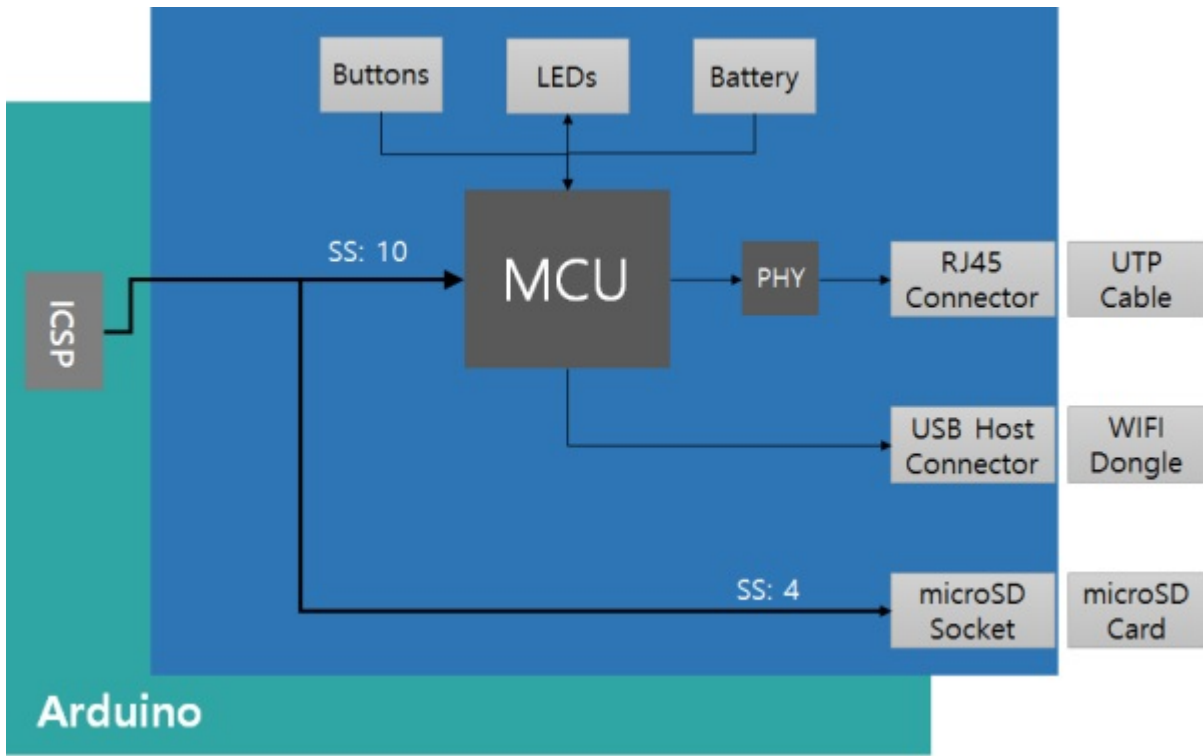

Dimension

The dimensions of PHPoC Shield for Arduino are as follows: (Unit: mm)

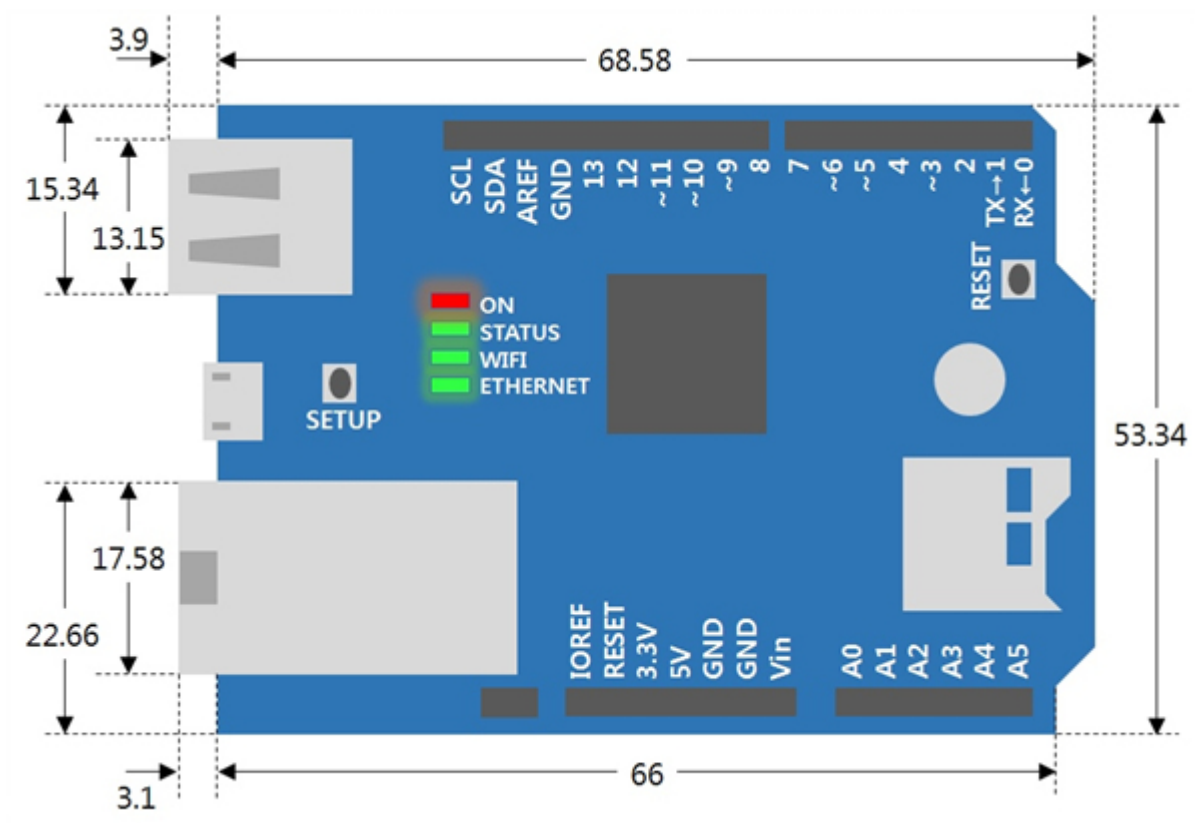

Weight

The weight is about 27.2g (without USB Wireless LAN dongle).

Communication with Arduino

PHPoC Shield for Arduino communicates to Arduino via SPI through ICSP header. SPI interface of the Arduino Uno and Mega is as follows:

Pin	Uno	Mega
MOSI	11	51
MISO	12	50
CLK	13	52
SS	10	10

On the Mega, the pin 53 must be kept as an output or the SPI interface won't work.

Connectors & Components

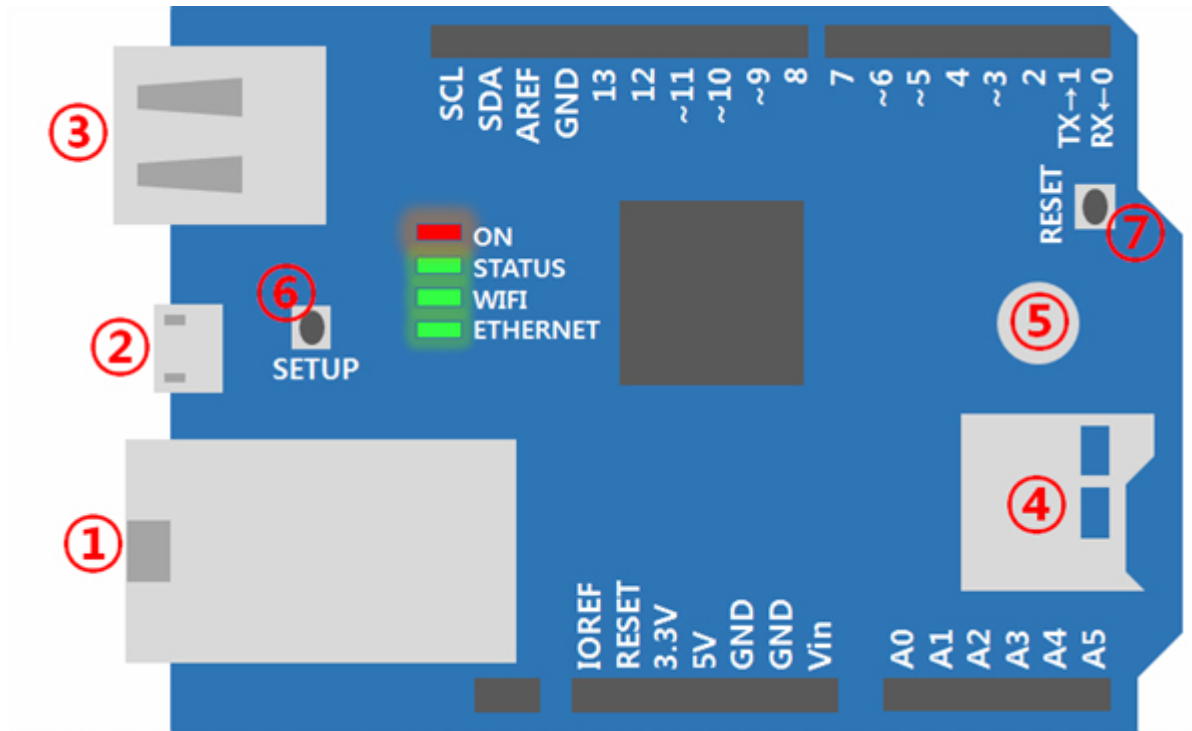

1. Ethernet Port

It supports 10M/100Mbit Ethernet.

2. Micro USB Port

It is a reserved port.

3. USB Port

It supports IEEE 802.11b/g wireless LAN. Connect a USB WIFI dongle to this port.

You must use a USB WIFI dongle equipped with Ralink RT3070 or RT5370 chipset.

4. MicroSD Socket

It provides a microSD card socket. Arduino directly communicates with SD memory through SPI. The SS pin of SPI for selecting SD memory communication is 4.

5. Built-in Battery

It provides a built-in battery for RTC features and saving log information.

6. SETUP Button

It is used to change or to initialize environment values to default value.

7. RESET Button

This button is for product reset.

LED Indicators

PHPoC Shield for Arduino has 4 LEDs to indicate the status of PHPoC Shield for Arduino.

- ON: shows that power is being supplied to the shield
- STATUS: indicates the operating state of the shield
 - Operation - toggle ON/OFF with the same duration
 - Others - blinks every second
- WIFI: indicates the wireless LINK state; blinks during data transmission/reception
- Ethernet: displays Ethernet LINK status; blinks during data transmission/reception

Schematic

This is the schematic of P4S-348.

- [P4S-348-R1-PO.pdf](#)

First Use (Web Serial Monitor)

The following is the process of monitoring the serial port of the Arduino using a smartphone. If you are new to PHPoC Shield for Arduino, do step by step.

First Use (Web Serial Monitor)

1. Connect PHPoC shield for Arduino to your Arduino.

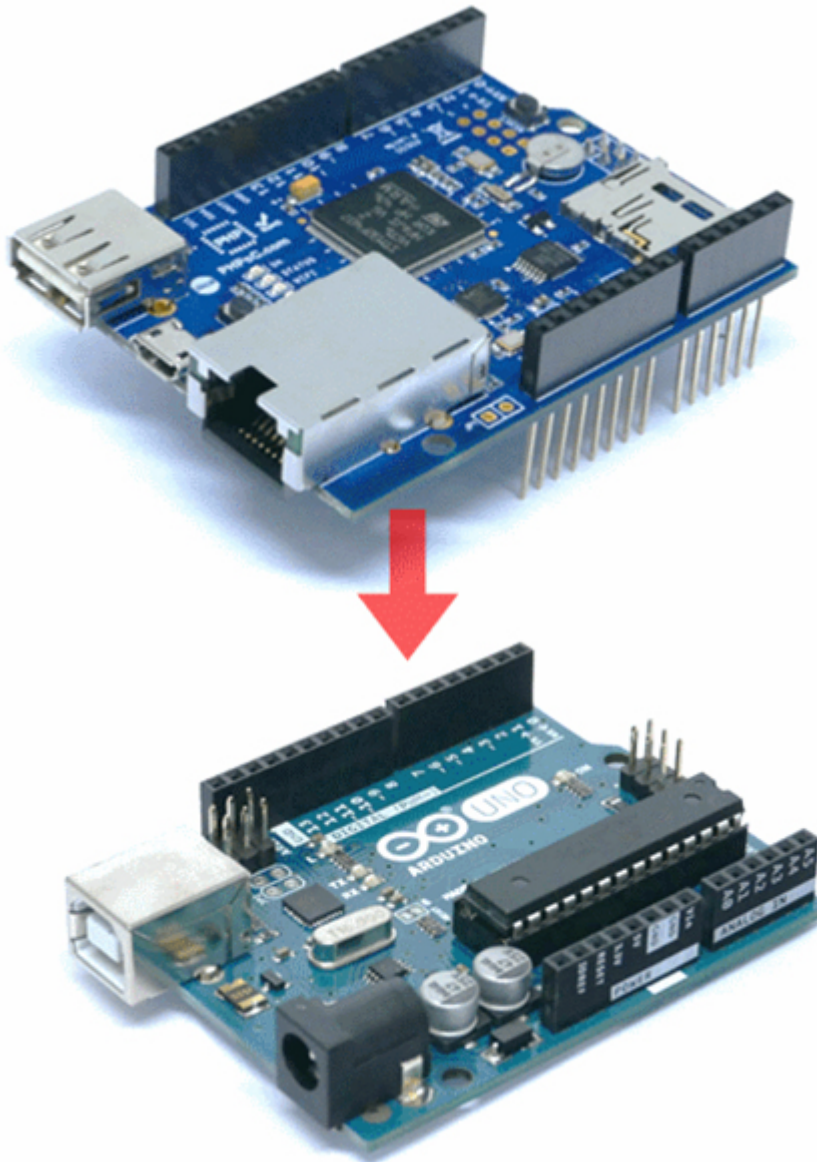

2. Insert a USB WIFI dongle to the shield.

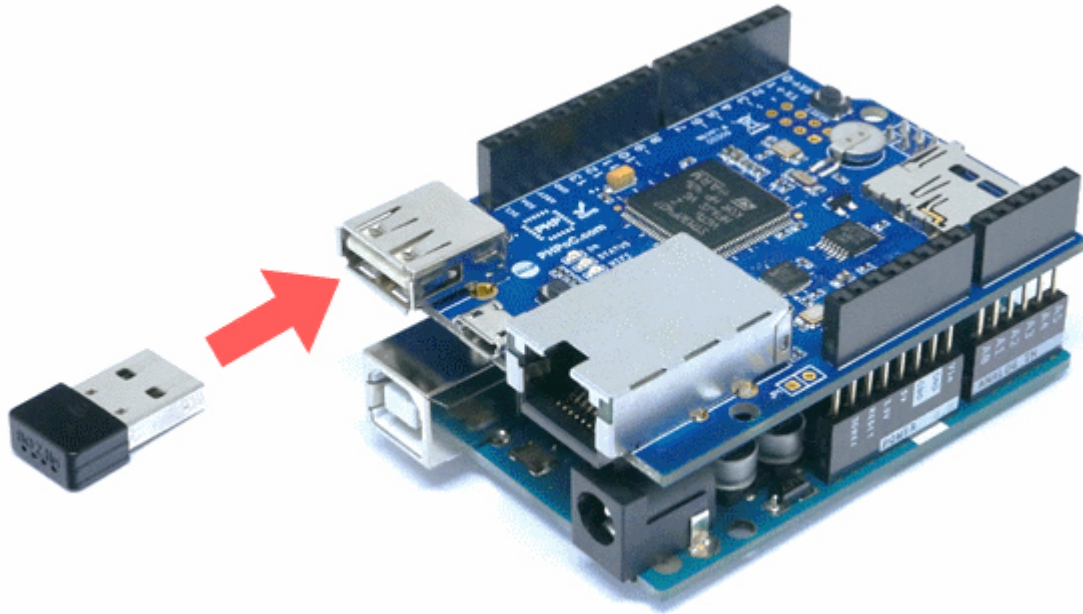

3. Connect the Arduino to your PC with a USB cable.

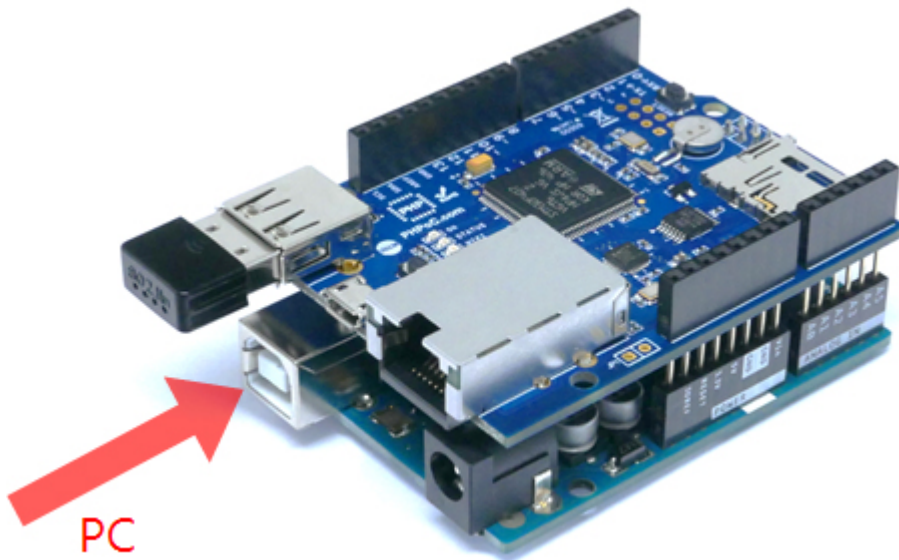

4. Run Arduino IDE on your PC.



5. Write sketch below and upload it to your Arduino.

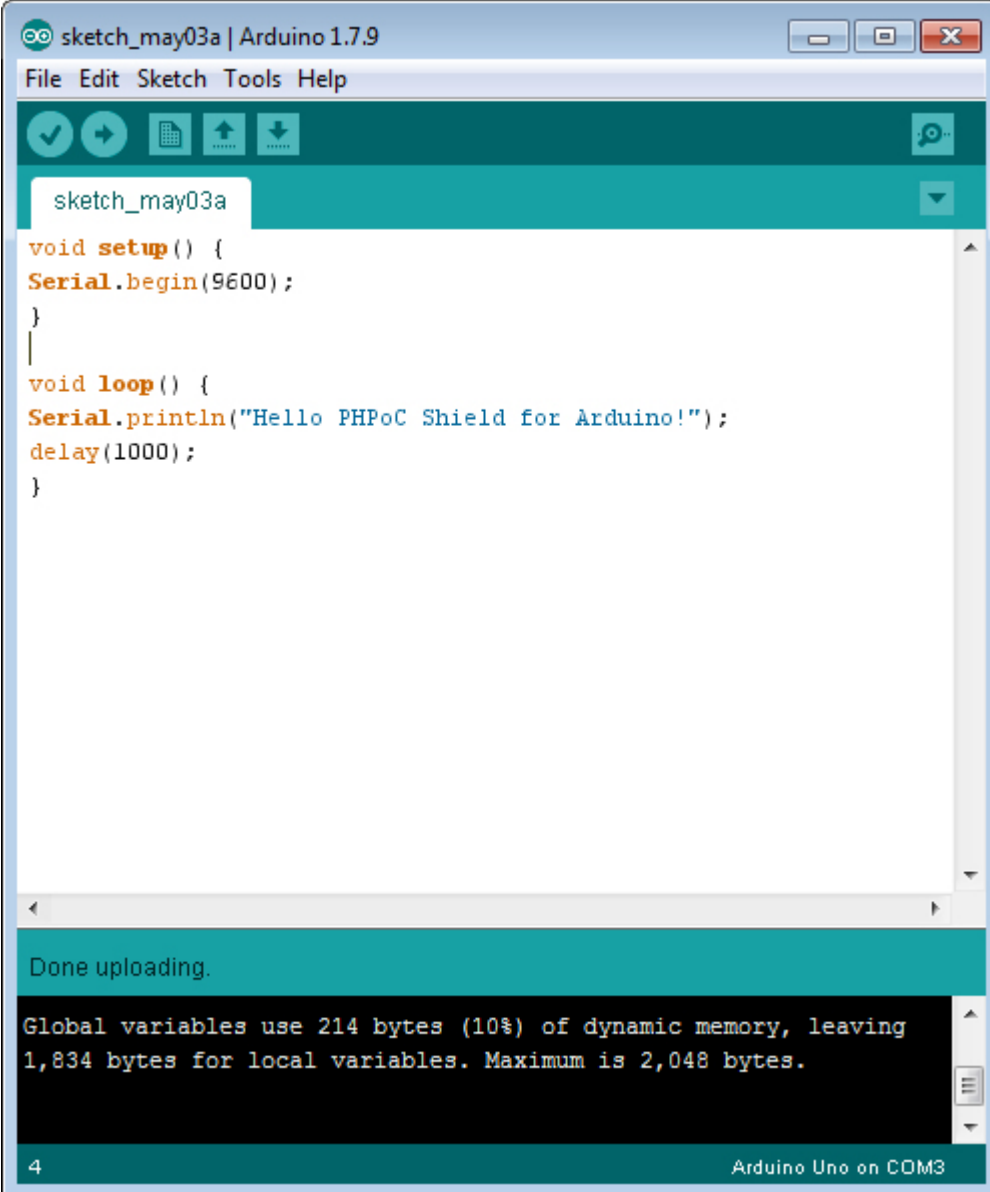

```
sketch_may03a | Arduino 1.7.9
File Edit Sketch Tools Help
sketch_may03a
void setup() {
  Serial.begin(9600);
}
void loop() {
  Serial.println("Hello PHPoC Shield for Arduino!");
  delay(1000);
}
Done uploading.
Global variables use 214 bytes (10%) of dynamic memory, leaving
1,834 bytes for local variables. Maximum is 2,048 bytes.
4 Arduino Uno on COM3
```

6. With your smartphone, connect to the wireless network starting with "phpoc_".

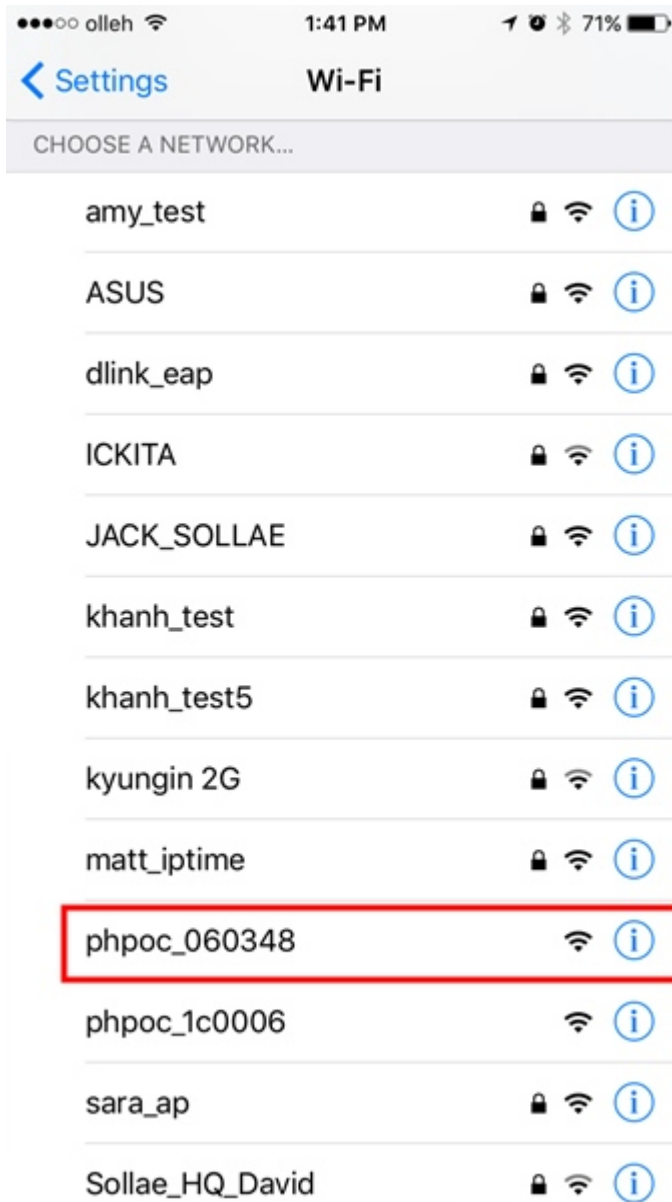

7. Run a web browser once it is properly connected to the wireless LAN.



8. Connect to the shield by entering "192.168.0.1" in the address bar.

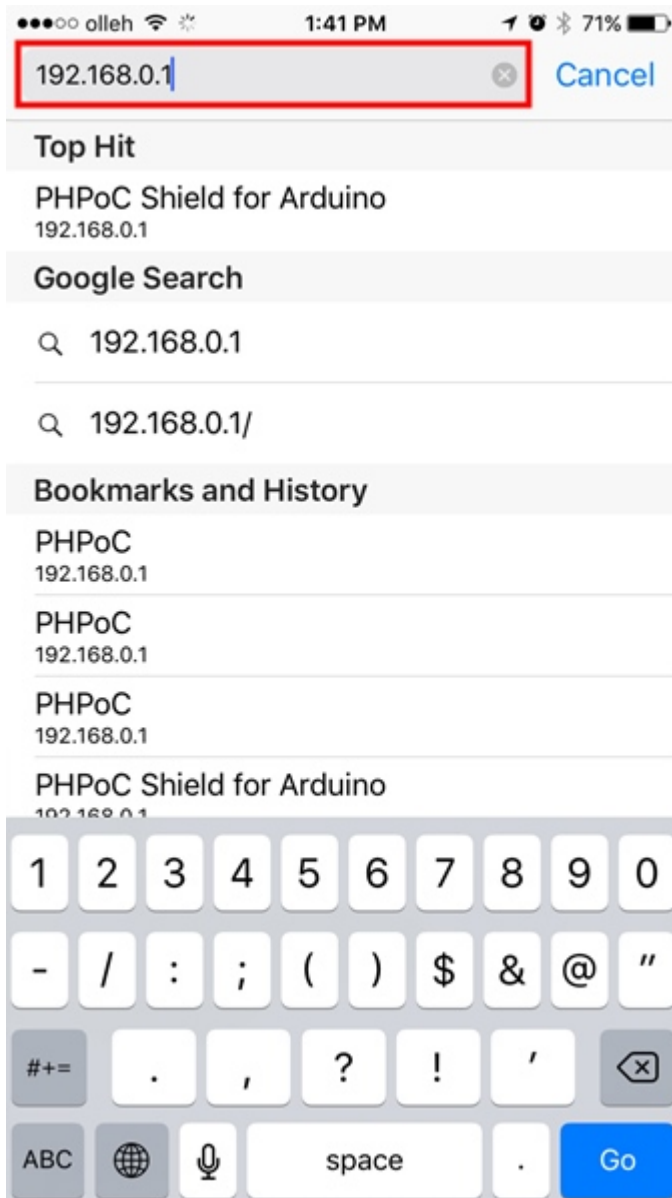

9. Select "Web Serial Monitor" on the main page.



10. Select the speed to "9600" and press the "Connect" button.



11. Once the connection is established, you can monitor the serial port of Arduino.



Set for the First Time

The existing Arduino Ethernet and WIFI shields set IP address and MAC address in the source codes. Unlike those shields, PHPoC Shield for Arduino provides a function which manages environment parameters related to the network of the shield itself. Using this shield, therefore, makes Arduino source codes more concise.

Here is how to set up parameters related to wired/wireless network on PHPoC Shield for Arduino for the first time. A smart phone or laptop is required for wireless LAN connection settings.

Set for The First Time

1. Connect PHPoC Shield for Arduino to your Arduino.

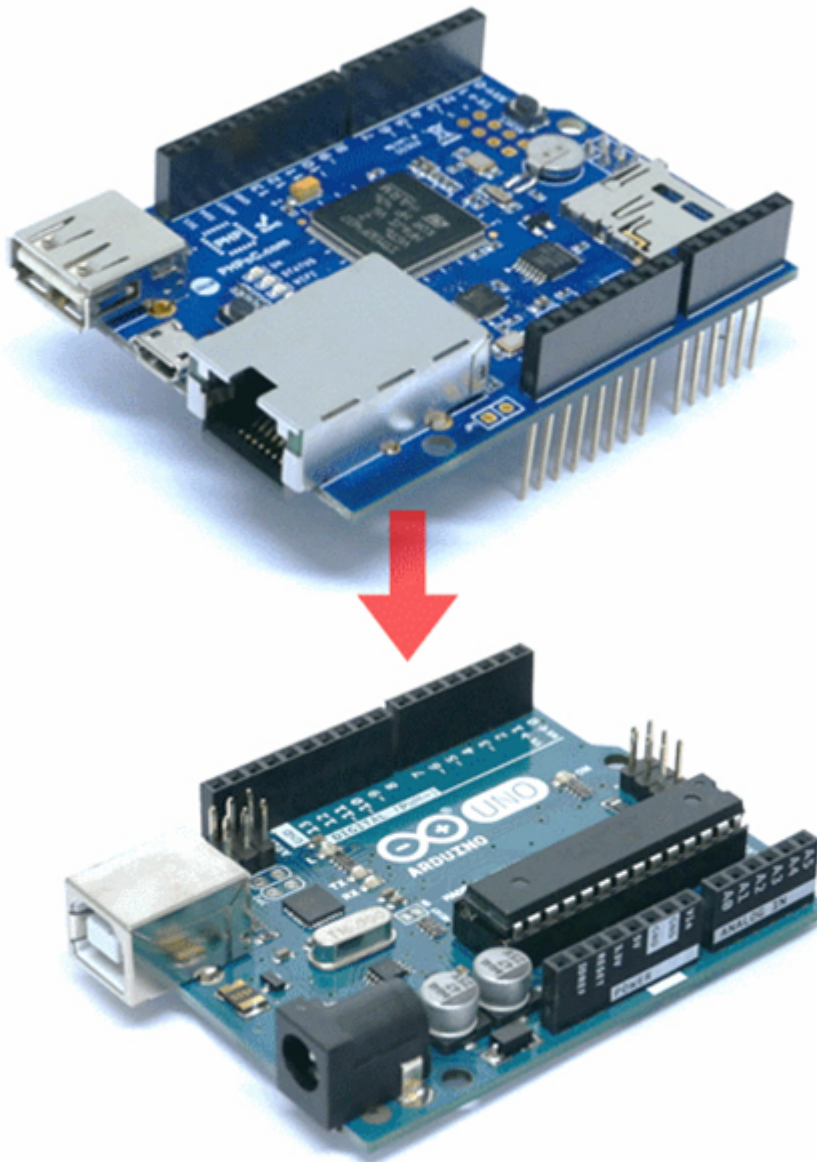

2. Input power to the Arduino.

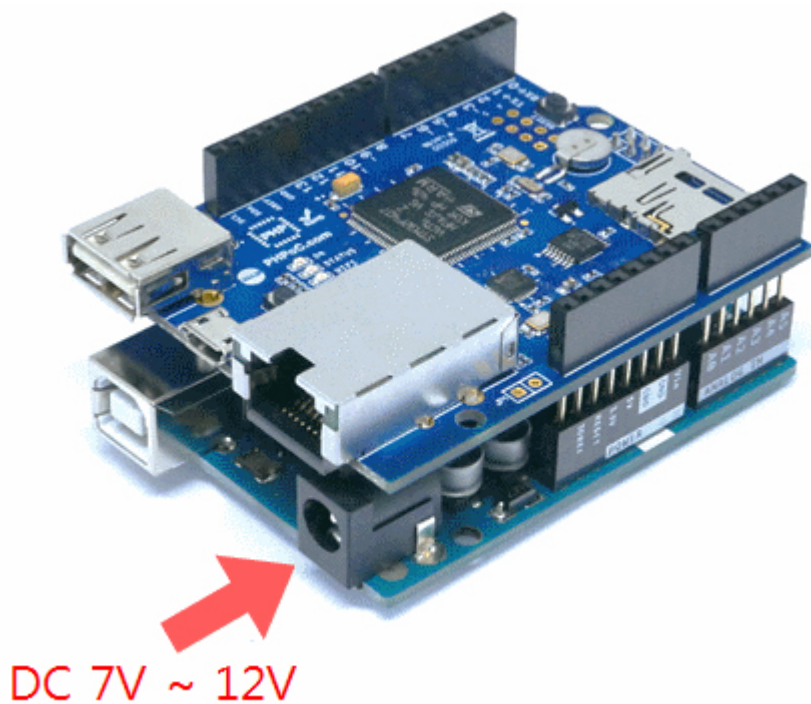

3. Insert a USB WIFI dongle to the shield.

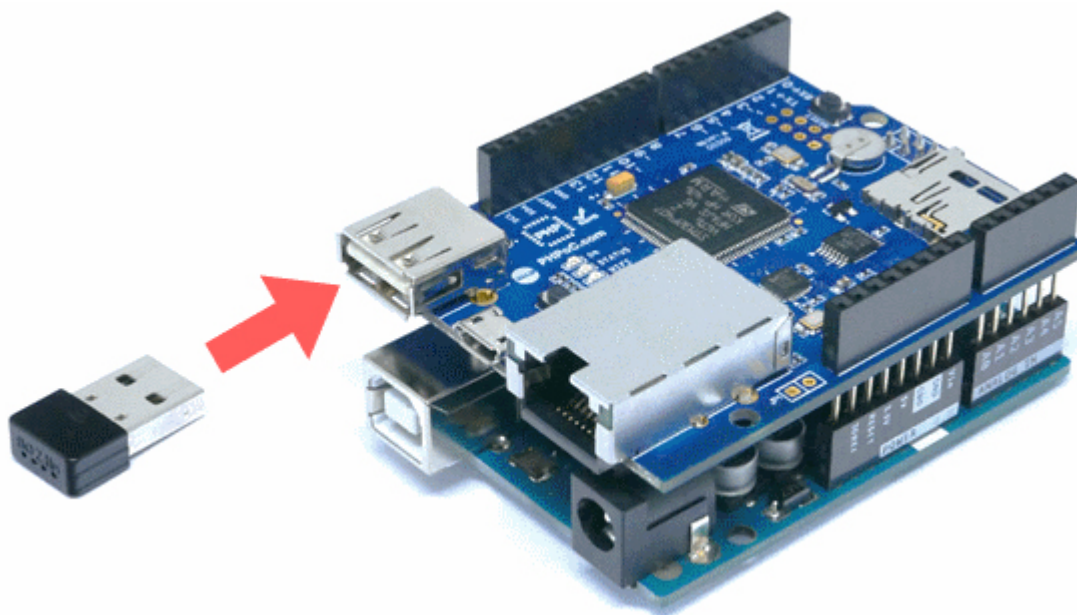

4. Push SETUP button on the shield once.

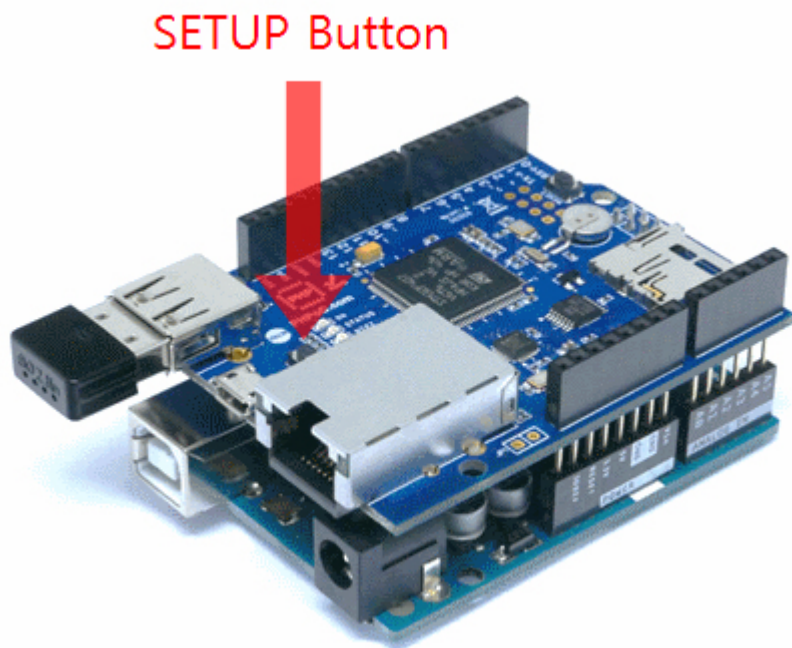

5. With your laptop or smartphone, connect to the wireless network starting with "phpoc_".

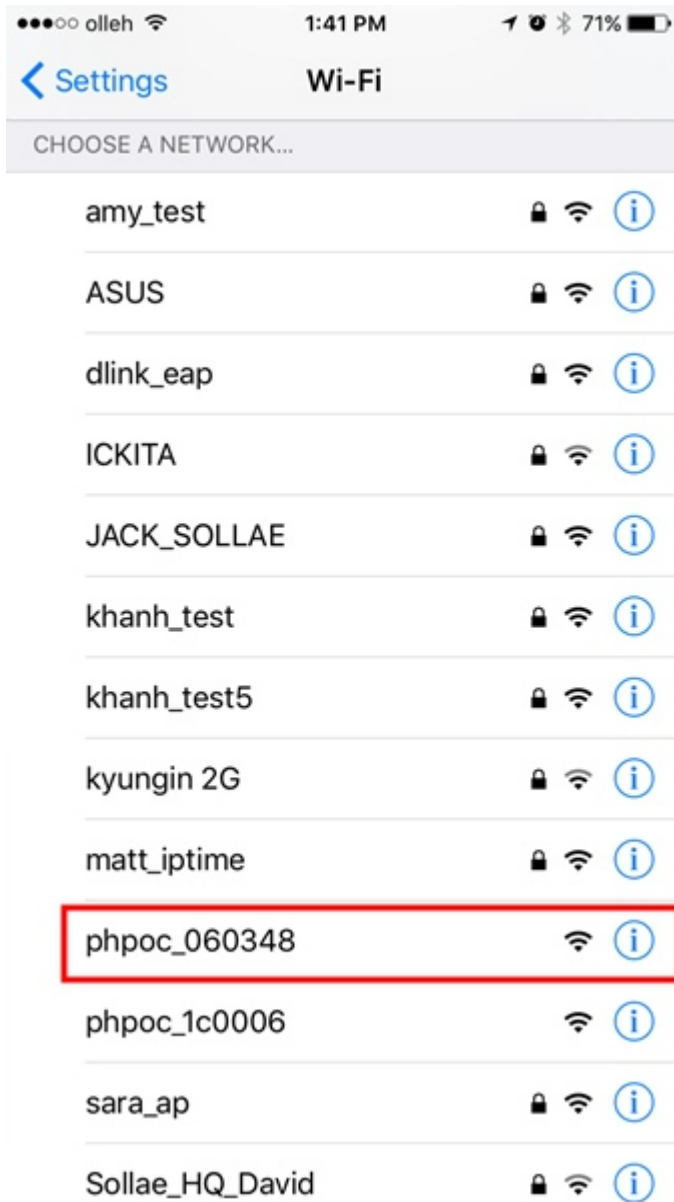

6. Run the web browser once it is properly connected to the wireless LAN.



7. Connect to the shield by entering "192.168.0.1" in the address bar.

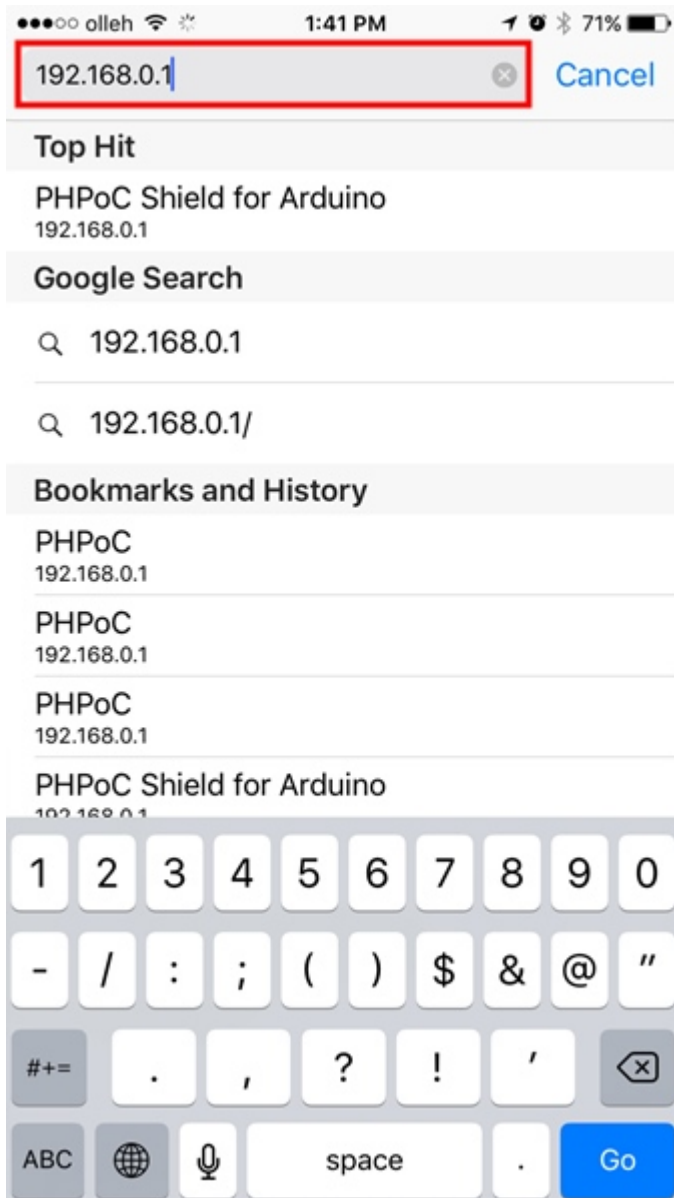

8. Once it is connected to the setup page, you can configure the network environment.

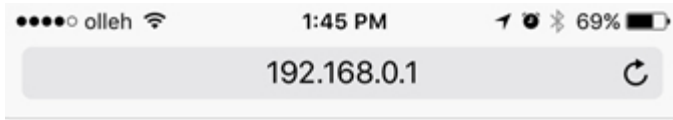

Setup

**PHPoC Shield is running in SETUP mode.
Web service is not available except SETUP.**

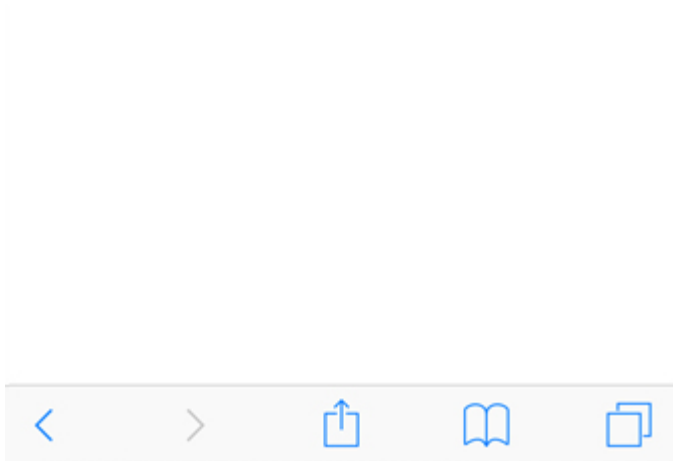

9. This is the screen of basic setup page.

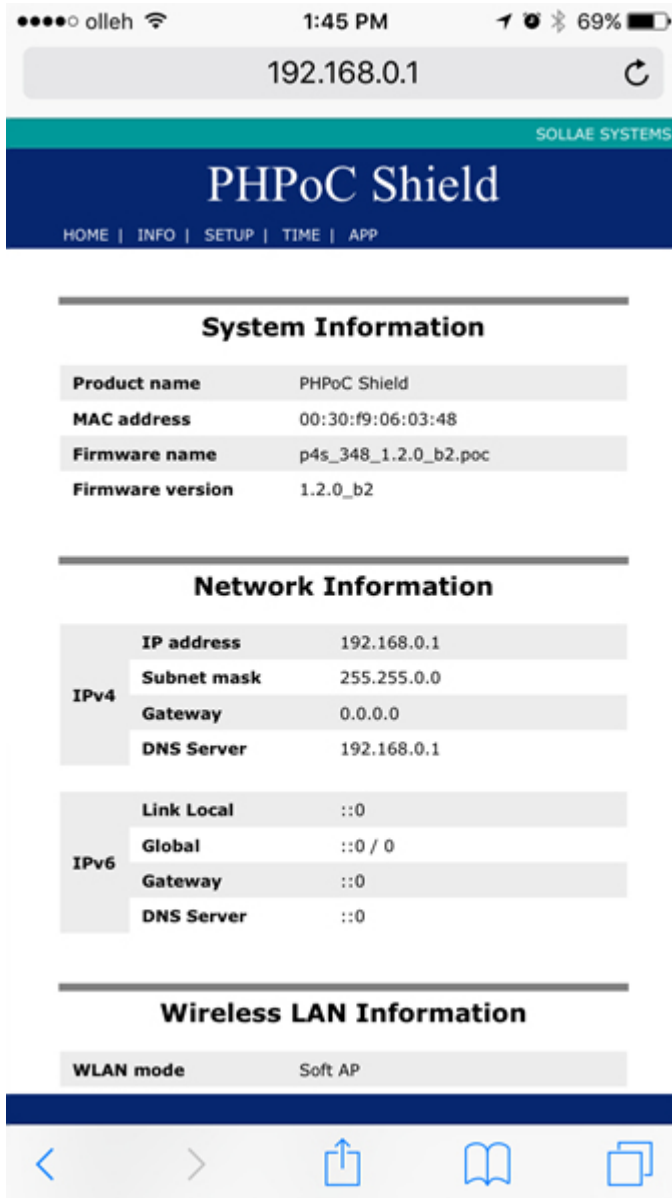

Operate Shield to AP



It is a mode to operate PHPoC shield for Arduino to AP by selecting Soft AP. Wireless LAN mode for PHPoC Shield for Arduino is set to Soft AP as the default value. Therefore, this mode can be used without additional set for using it for the [First Use](#).

However, when you want to change the WLAN name (SSID) or channel you can change the settings using the following procedure.

Operate Shield to AP

1. Connect to the Web setup page of the shield according to the instructions from [Set for the First time](#).

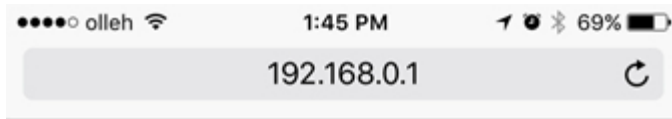

Setup

**PHPoC Shield is running in SETUP mode.
Web service is not available except SETUP.**

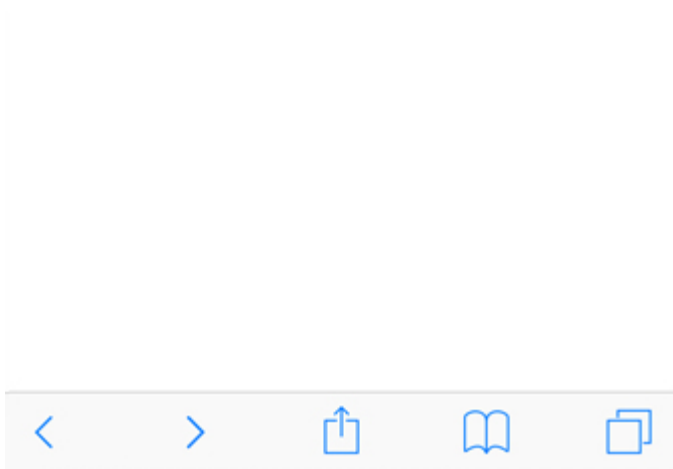

2. Move to the SETUP page.

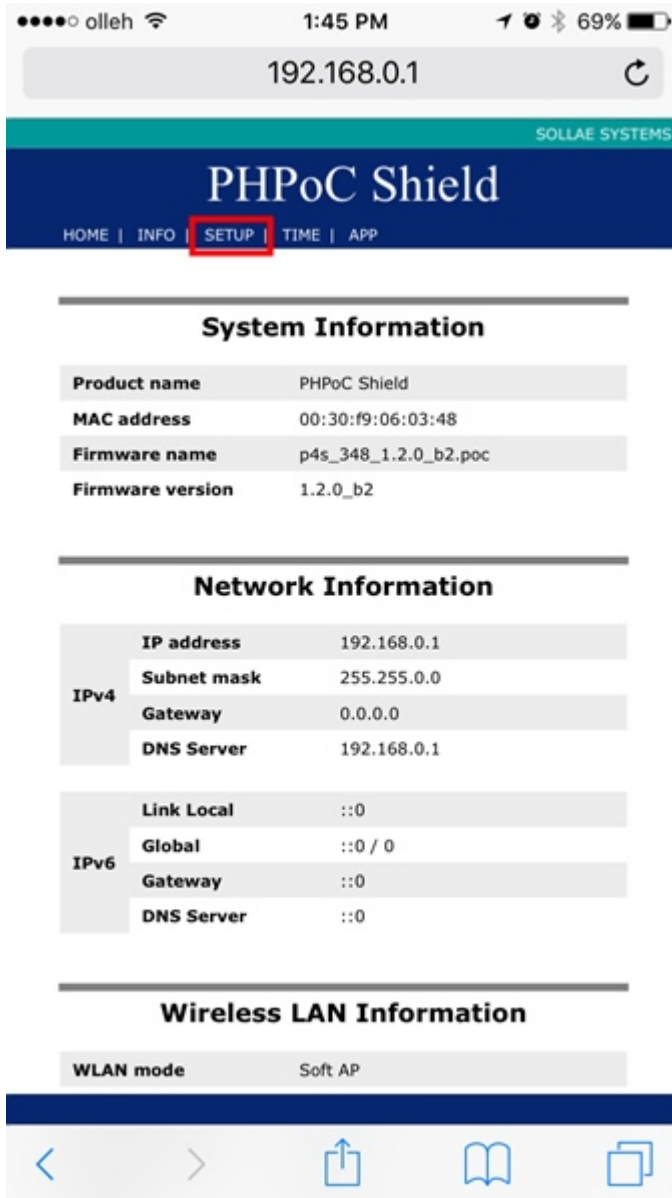

3. Select Soft AP of the WLAN mode in the Wireless LAN category.

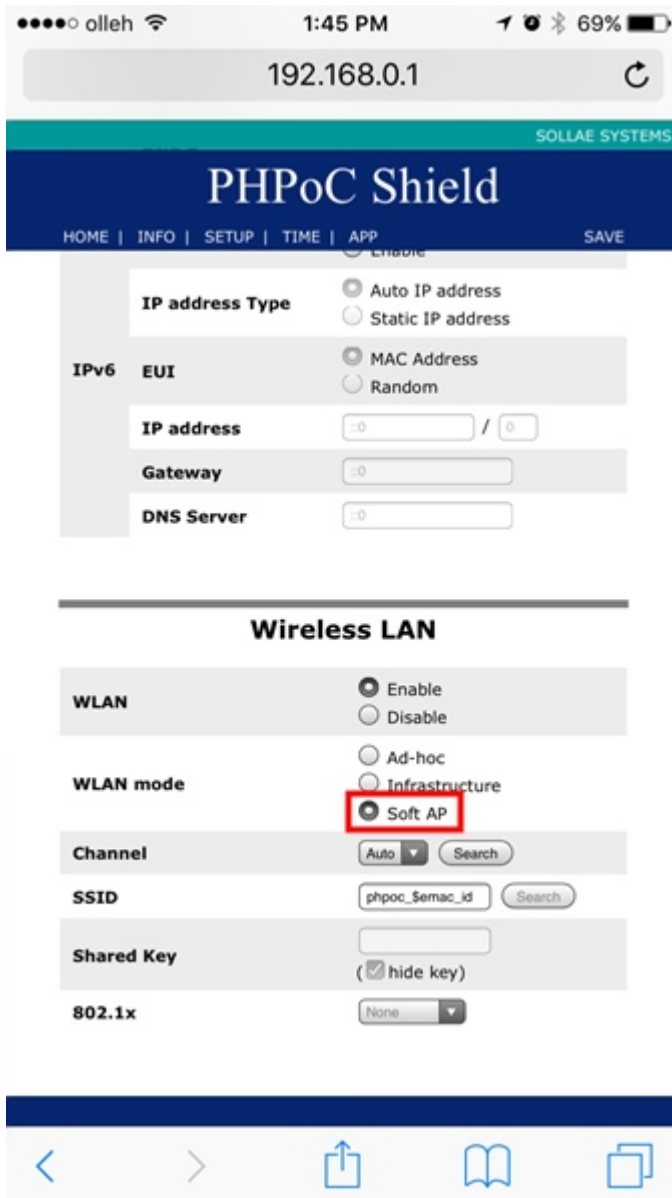

4. Click 'Search' on Channel item.

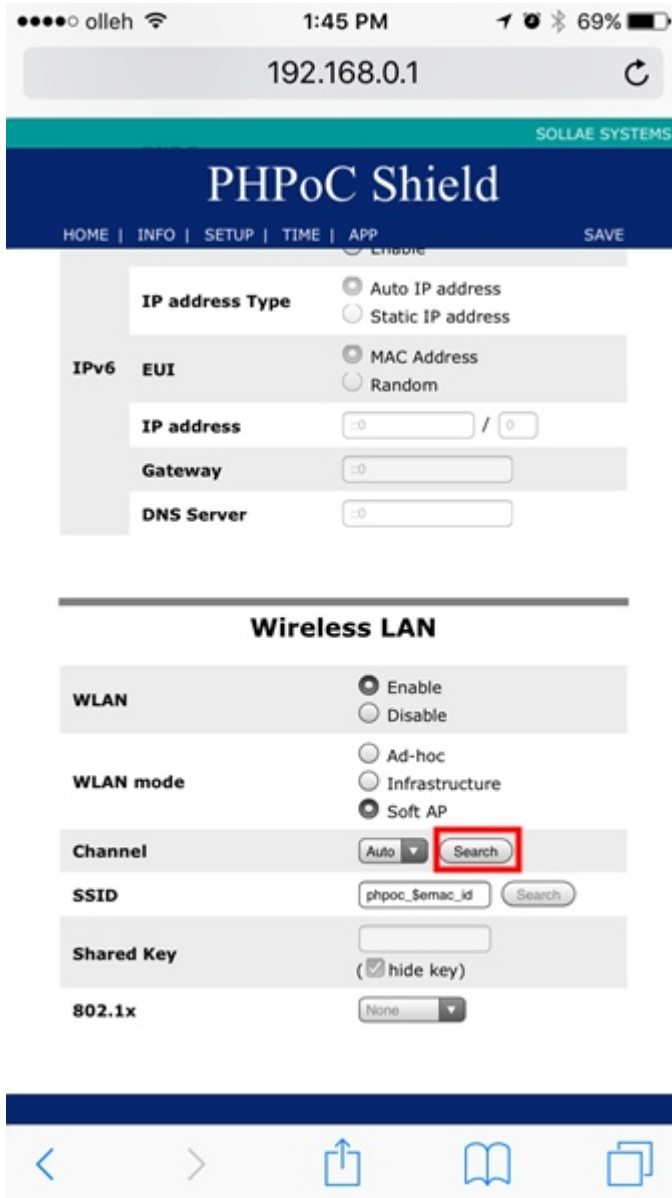

5. Locate and select the less popular channels in the new pop-up Channel List page.

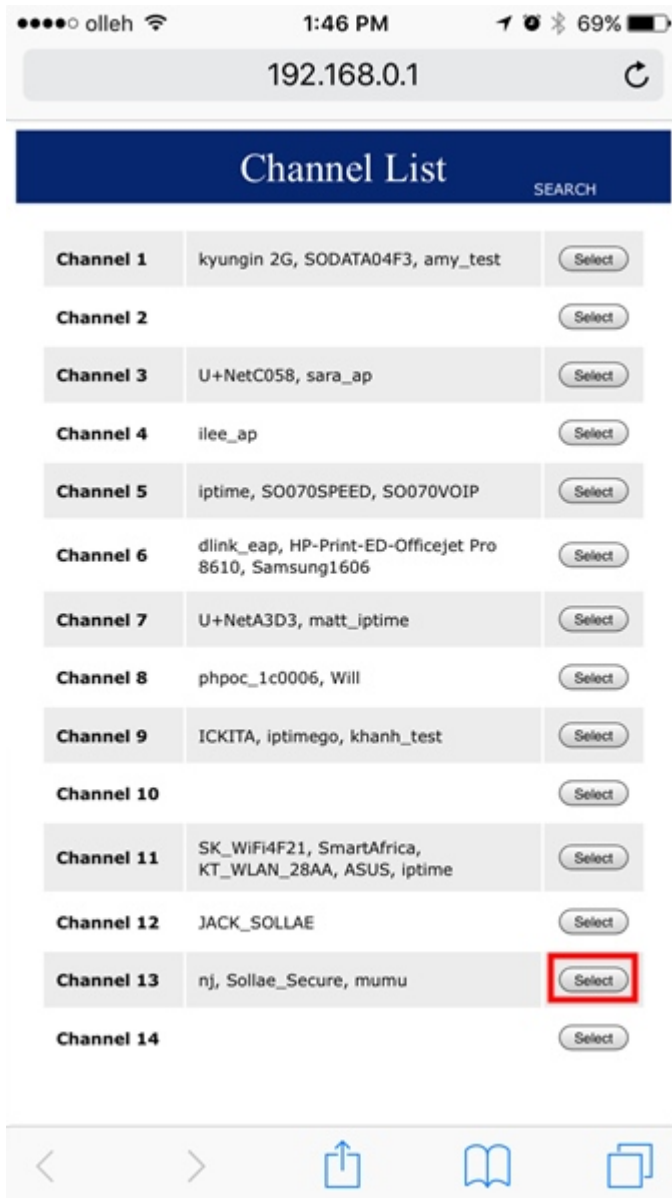

6. Enter arbitrarily the SSID to use in the SSID.

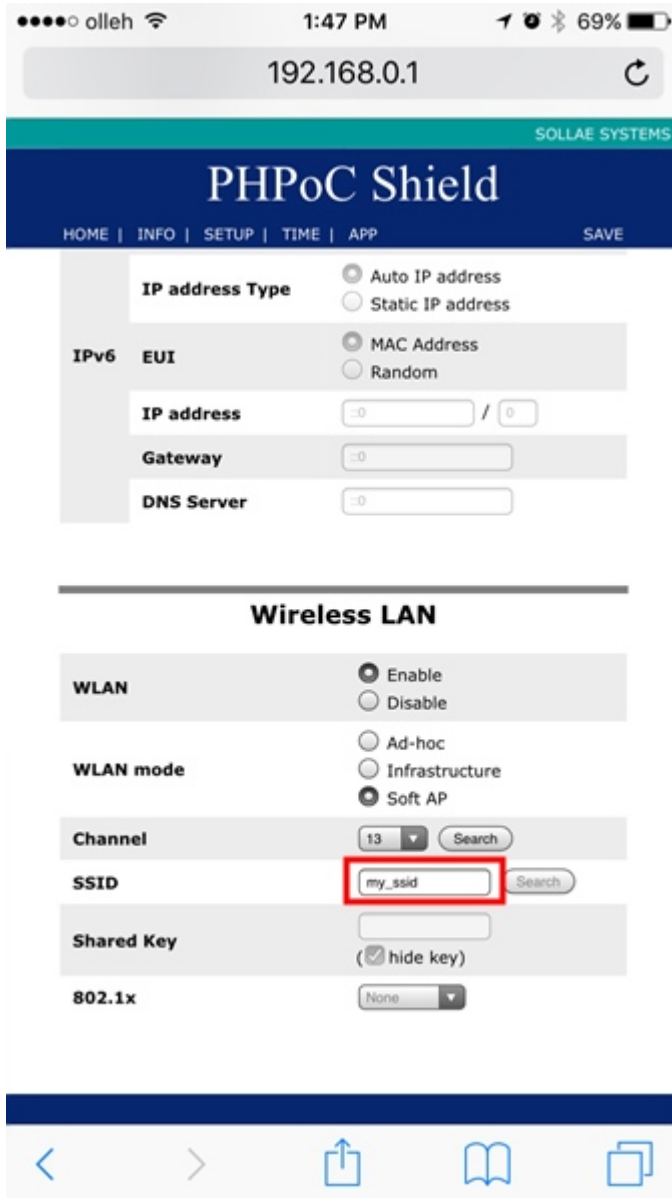

7. Click 'Save' on the top right.

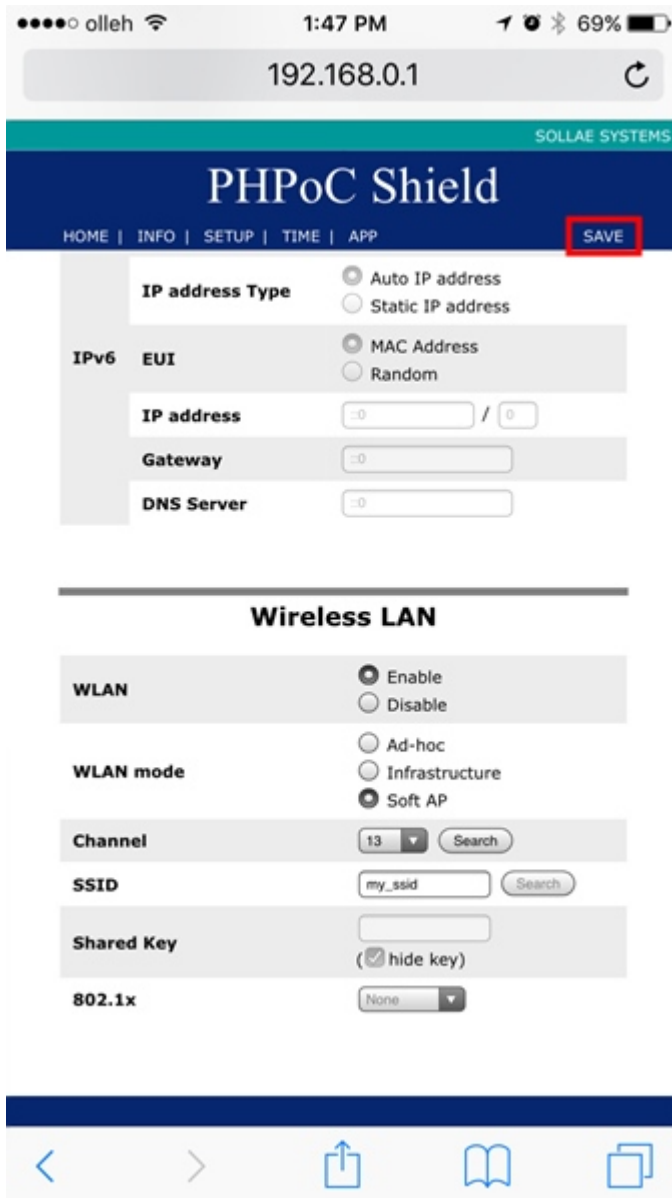

8. The message below indicates that the setup is complete.

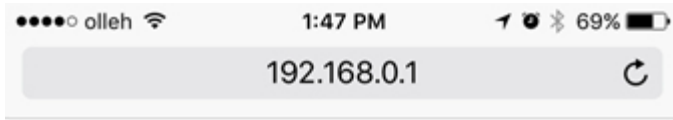

IP address may be changed. Please check newly assigned IP address from PHPoC Debugger and reconnect to the device.

setup complete



9. Search SSID from step 6 and connect to WLAN.

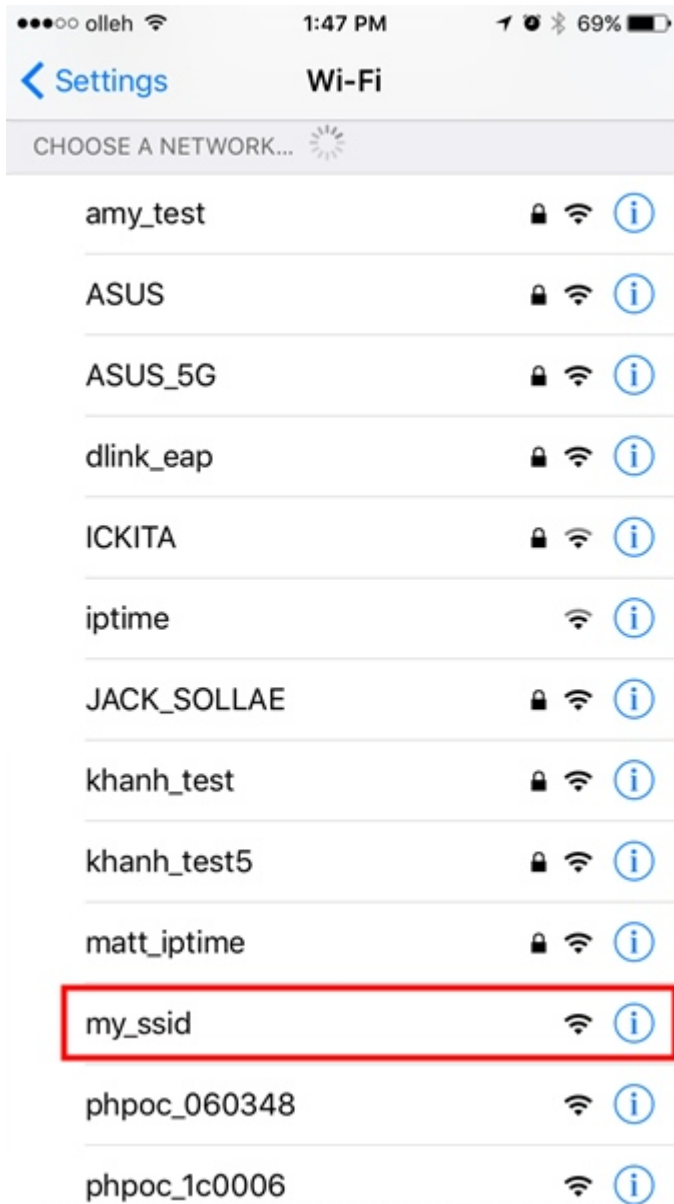

10. Rerun the web browser and type 192.168.0.1 into the address bar to access.



Connect Shield to WLAN Router or AP



In order to connect the PHPoC Shield for Arduino to a WIFI router or AP, you must set up your wireless LAN as infrastructure mode. This mode is the most common wireless LAN mode where a plurality of wireless network devices including AP is connected.

Connect Shield to WLAN Router or AP

1. Connect to the Web setup page of PHPoC Shield for Arduino according to the instructions from [Set for the First time](#).

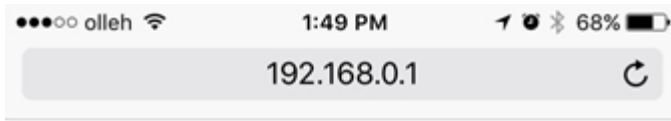

Setup

**PHPoC Shield is running in SETUP mode.
Web service is not available except SETUP.**

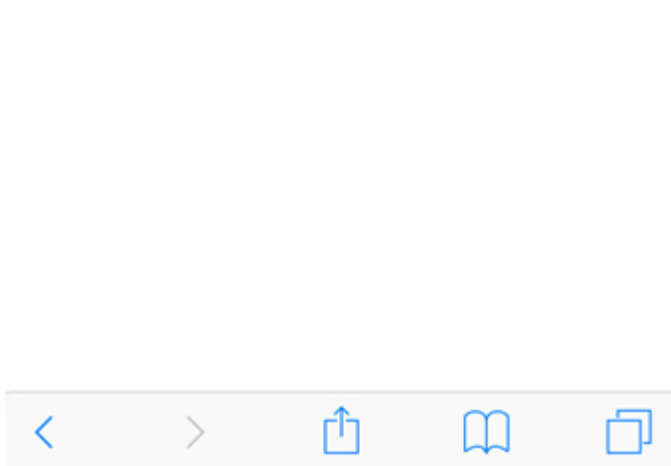

2. Move to the SETUP page.

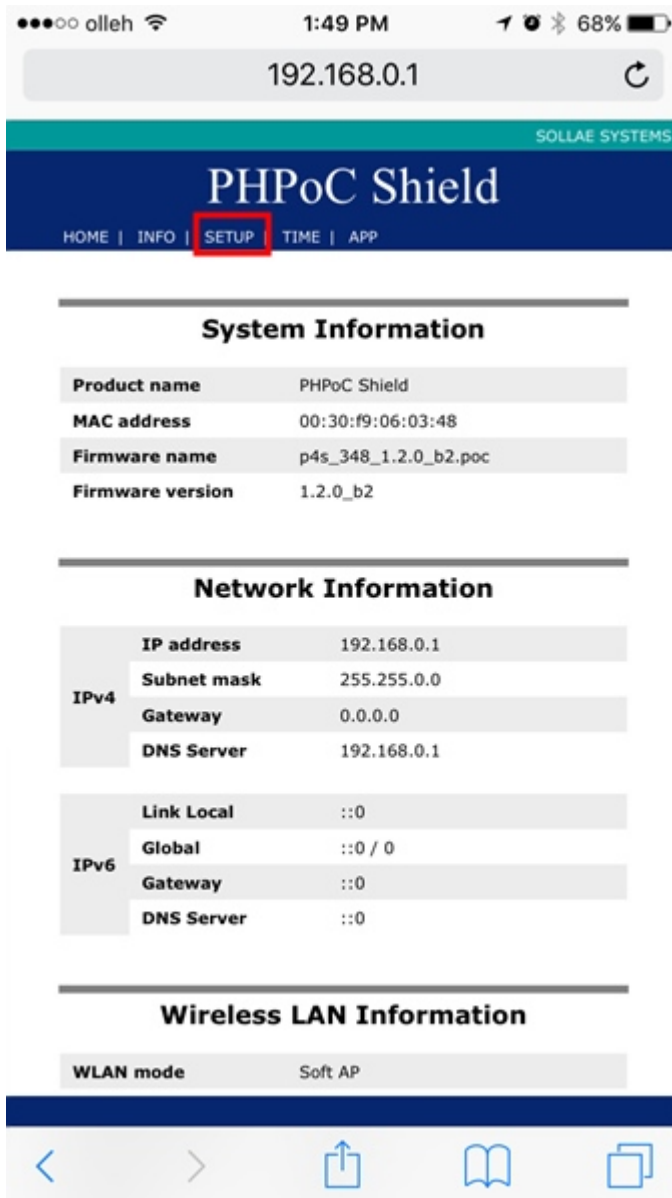

3. Select "Infrastructure" for WLAN mode in the Wireless LAN category.

The screenshot shows the PHPoC Shield web interface. At the top, the status bar displays signal strength, the carrier name 'olleh', the time '1:49 PM', and the IP address '192.168.0.1'. The page title is 'PHPoC Shield' by SOLLAE SYSTEMS. The navigation menu includes 'HOME | INFO | SETUP | TIME | APP' and a 'SAVE' button.

The 'DNS Server' field is set to '0.0.0.0'. The 'IPv6' section has 'Disable' selected. Under 'IP address Type', 'Auto IP address' is selected. Under 'IPv6 EUI', 'MAC Address' is selected. The 'IP address' field is set to '-:0 / 0', 'Gateway' is '-:0', and 'DNS Server' is '-:0'.

The 'Wireless LAN' section is expanded. 'WLAN' is 'Enable'. Under 'WLAN mode', 'Infrastructure' is selected and highlighted with a red box. Other options are 'Ad-hoc' and 'Soft AP'. The 'Channel' is set to 'Auto' with a 'Search' button. The 'SSID' is 'my_ssid' with a 'Search' button. The 'Shared Key' is hidden (checked). The '802.1x' setting is 'None'.

4. Click "Search" in the SSID.

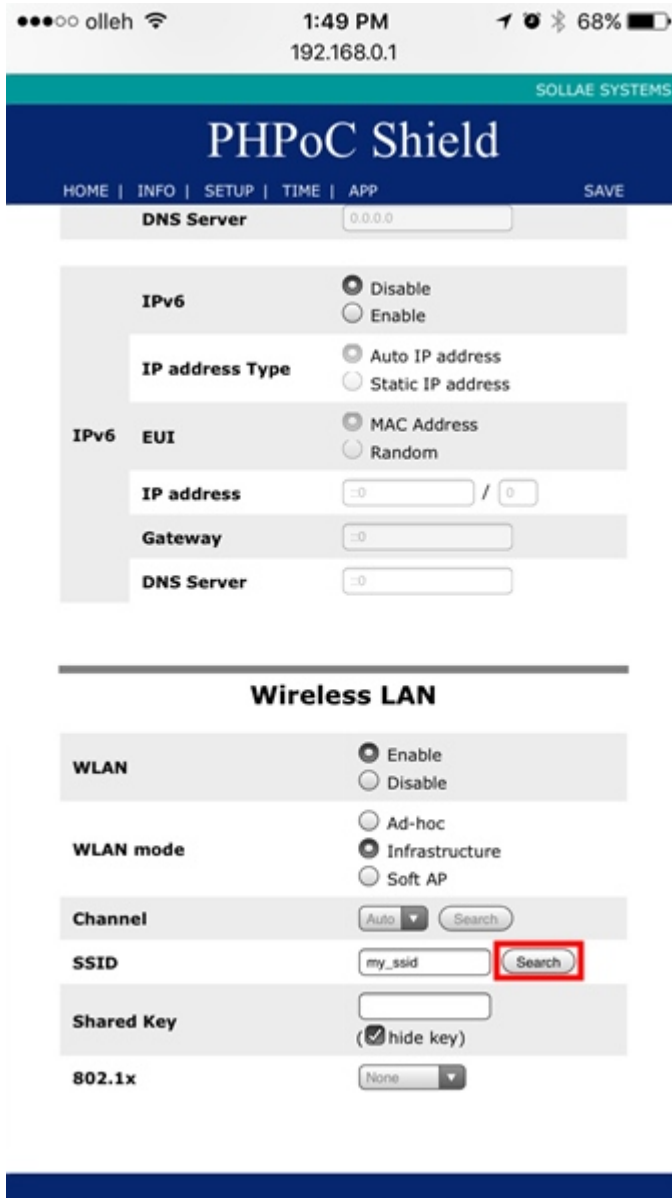

5. Search and select the AP you are going to connect on the new popup AP List page.

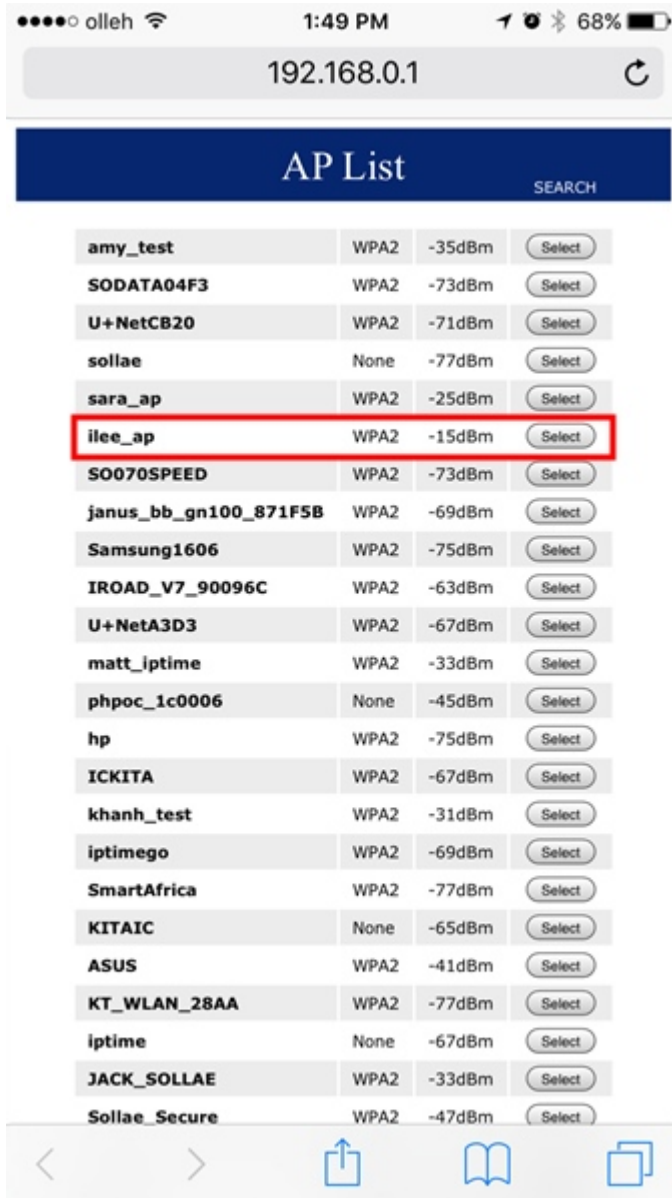

6. Enter AP security key for the Shared Key.

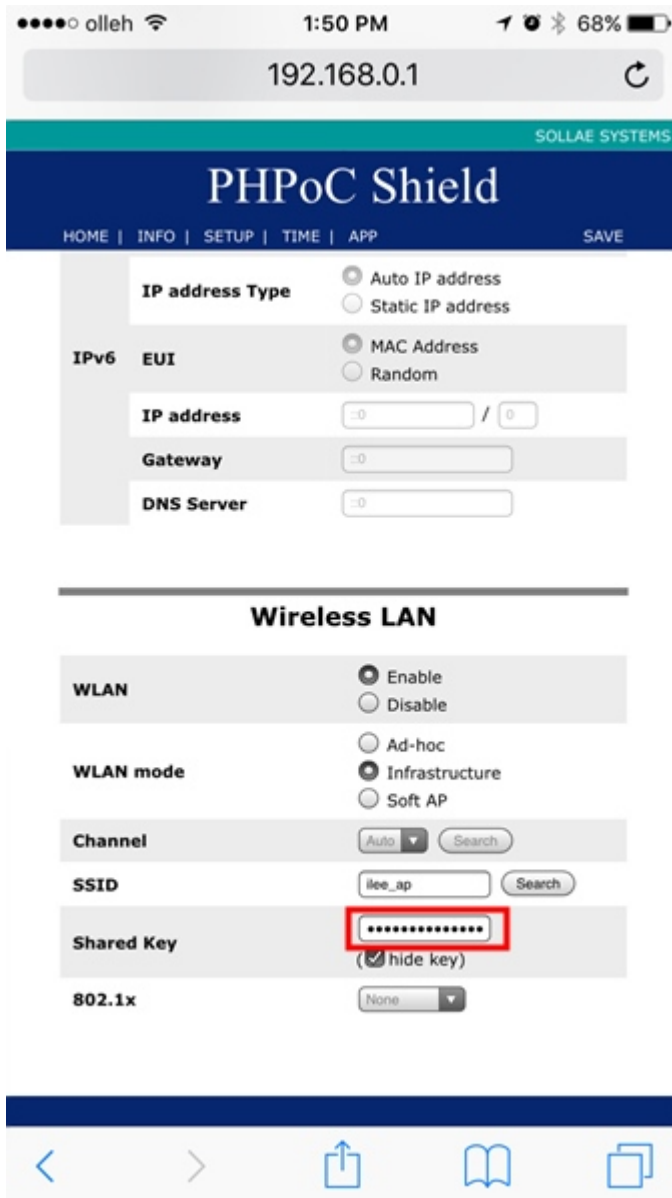

7. Click "SAVE" on the top right.

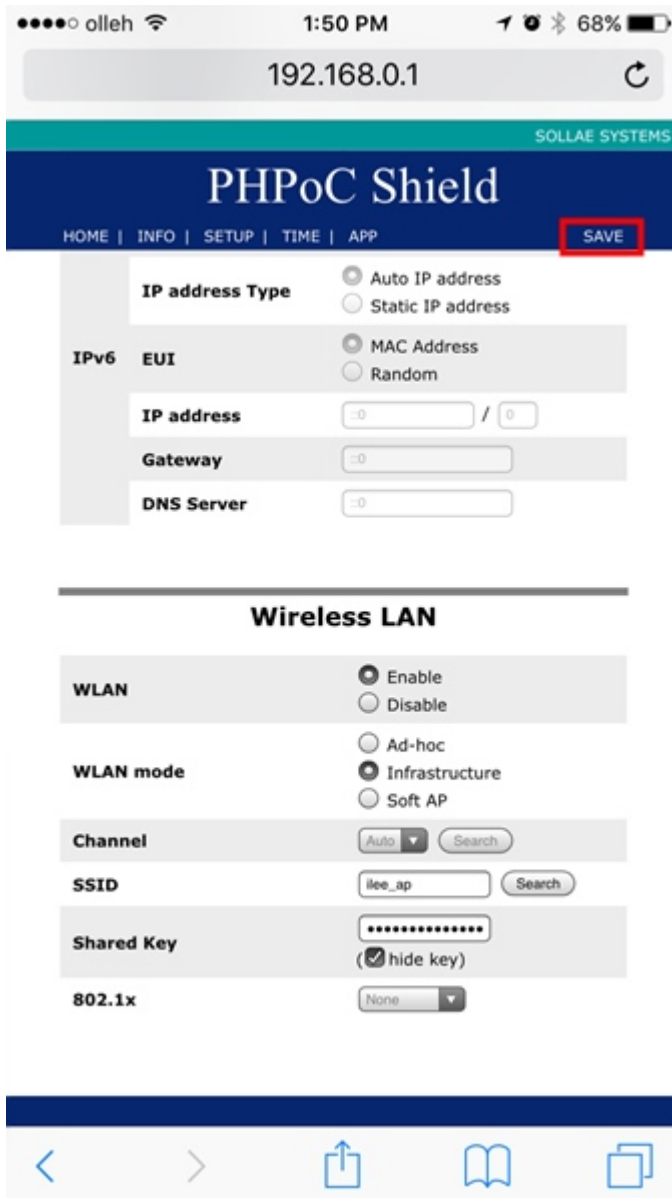

8. The message below indicates that the setup is complete.

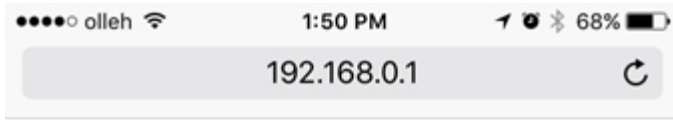

IP address may be changed. Please check newly assigned IP address from PHPoC Debugger and reconnect to the device.

setup complete



Connect Shield to the Ethernet

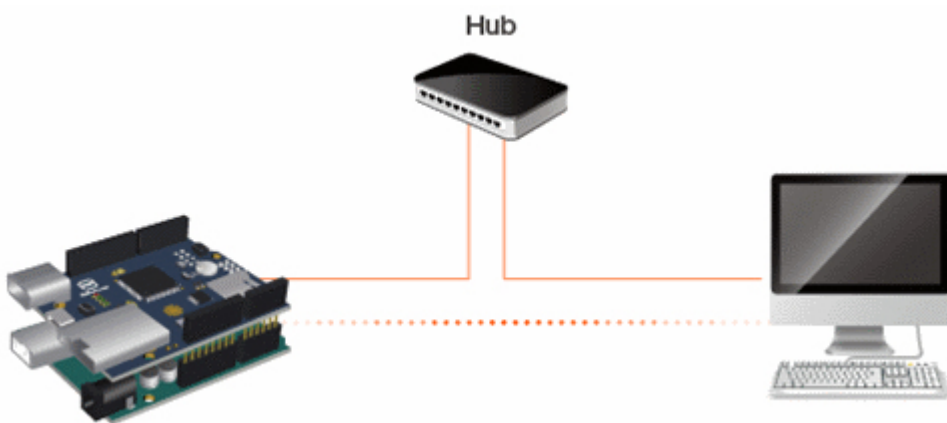

The shield can be connected to the Ethernet if any one of those two conditions are followed:

- If wireless LAN is set to "disable"
- If no USB dongle is connected to the shield.

Connect Shield to the Ethernet

1. Connect LAN cable to the shield without connecting a USB WLAN dongle.

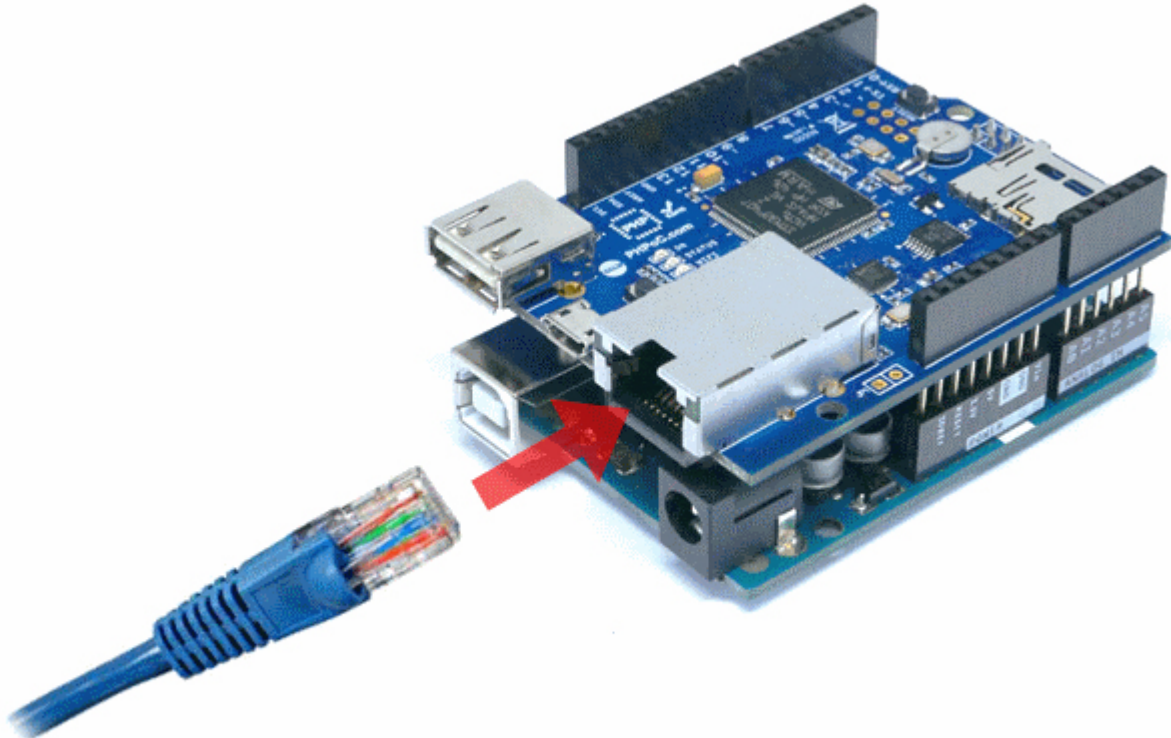

2. Check the IP address according to the instructions from [Verifying the IP Address](#).

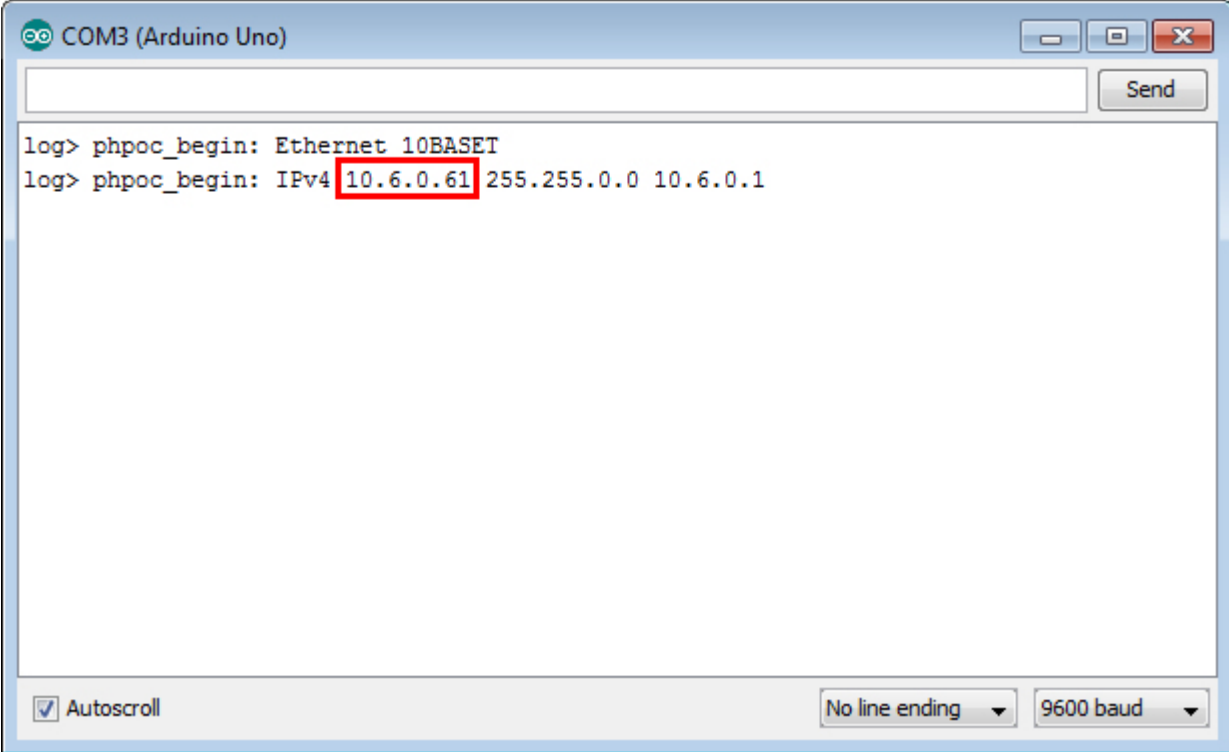

```
log> phpoc_begin: Ethernet 10BASET
log> phpoc_begin: IPv4 10.6.0.61 255.255.0.0 10.6.0.1
```

Refer to the [Manual IP setup](#) if you want to set the IP address by yourself.

Automatical IP Address Setup

If there is a device assigning the IP address such as router on the user's network, you can automatically set the IP address.

1. Connect to Web setup page of PHPoC Shield for Arduino.

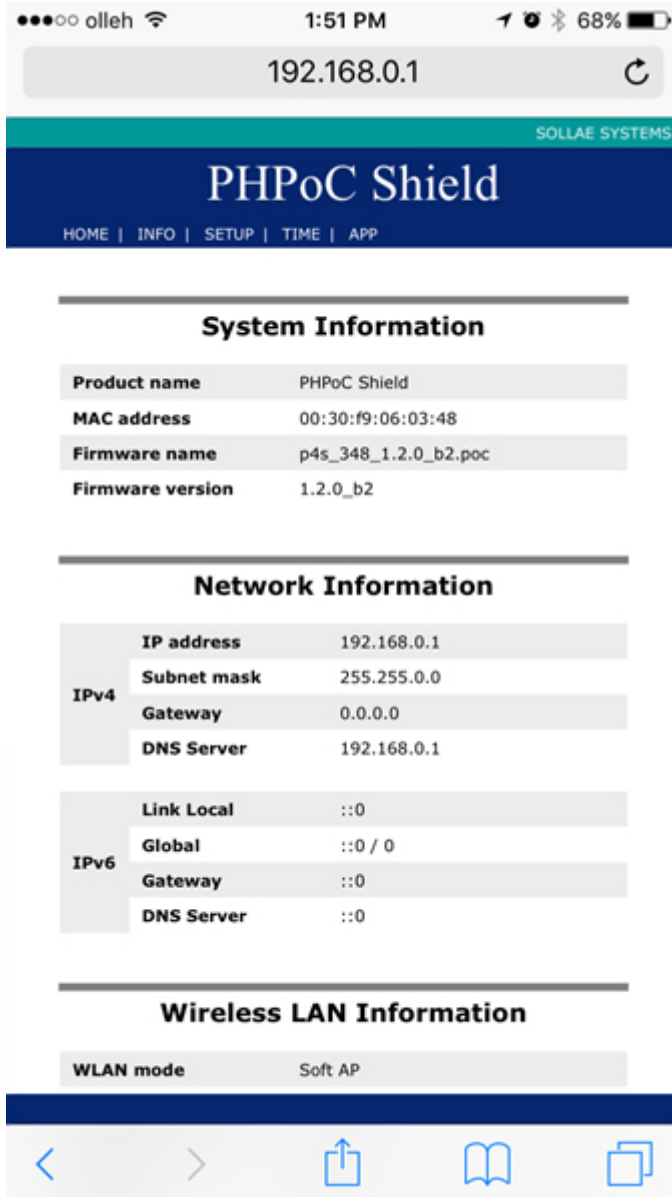

2. Move to the SETUP page.

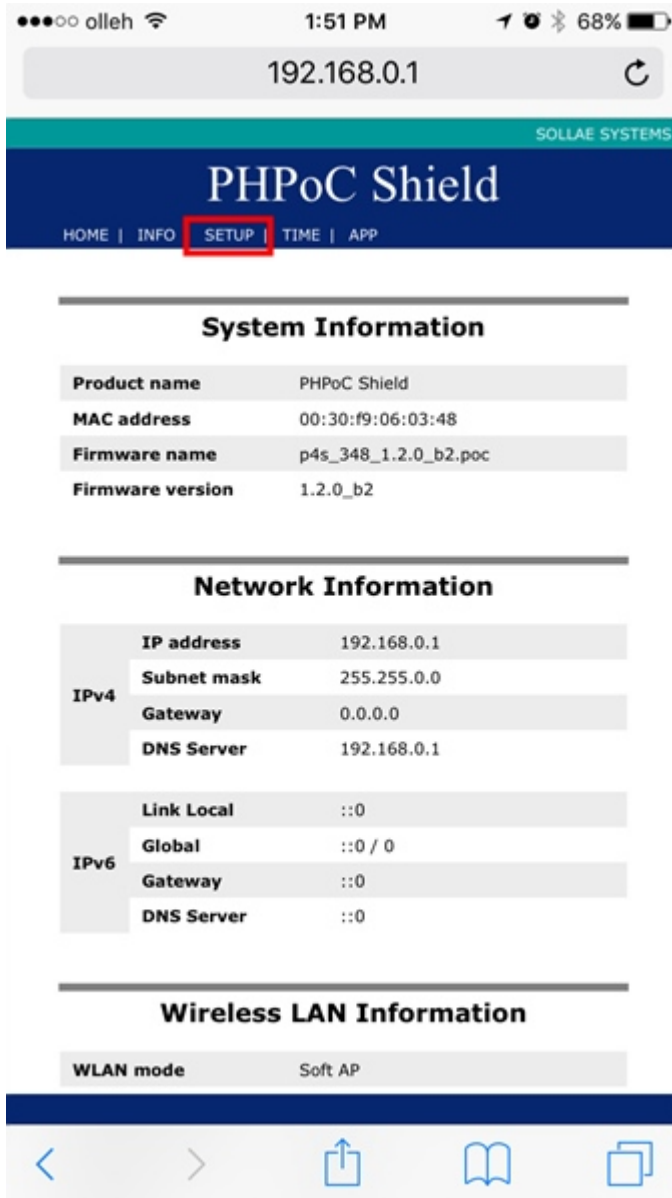

3. Select Auto IP address for IP Address Type.

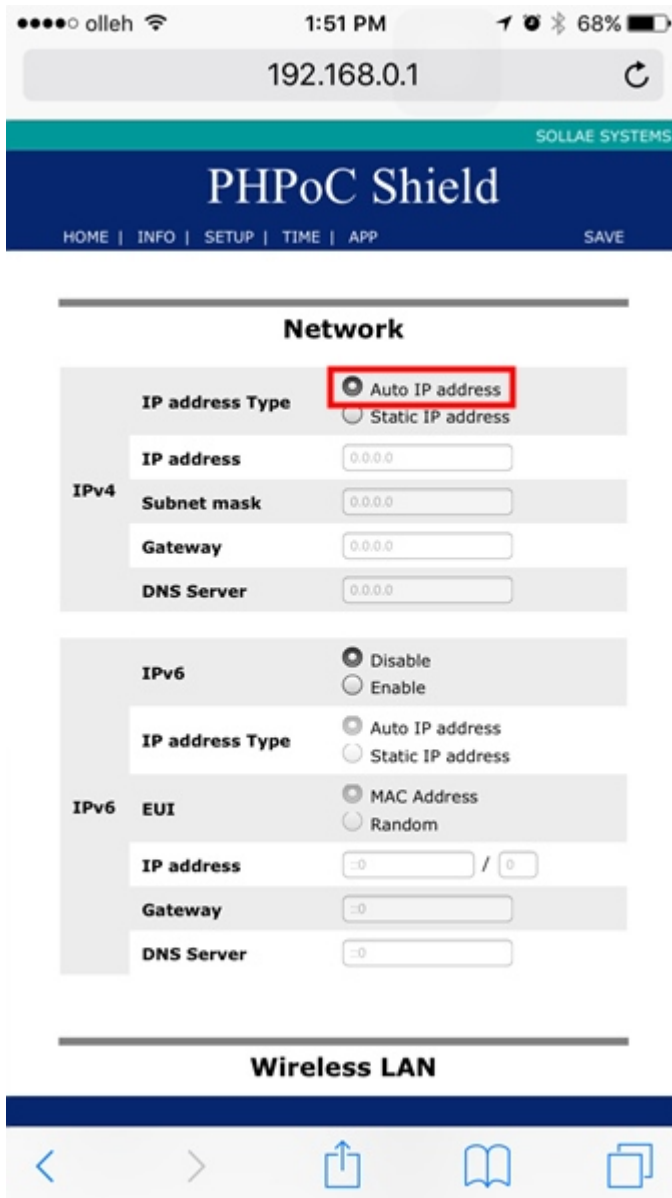

4. Click "SAVE" on the top right of the page.

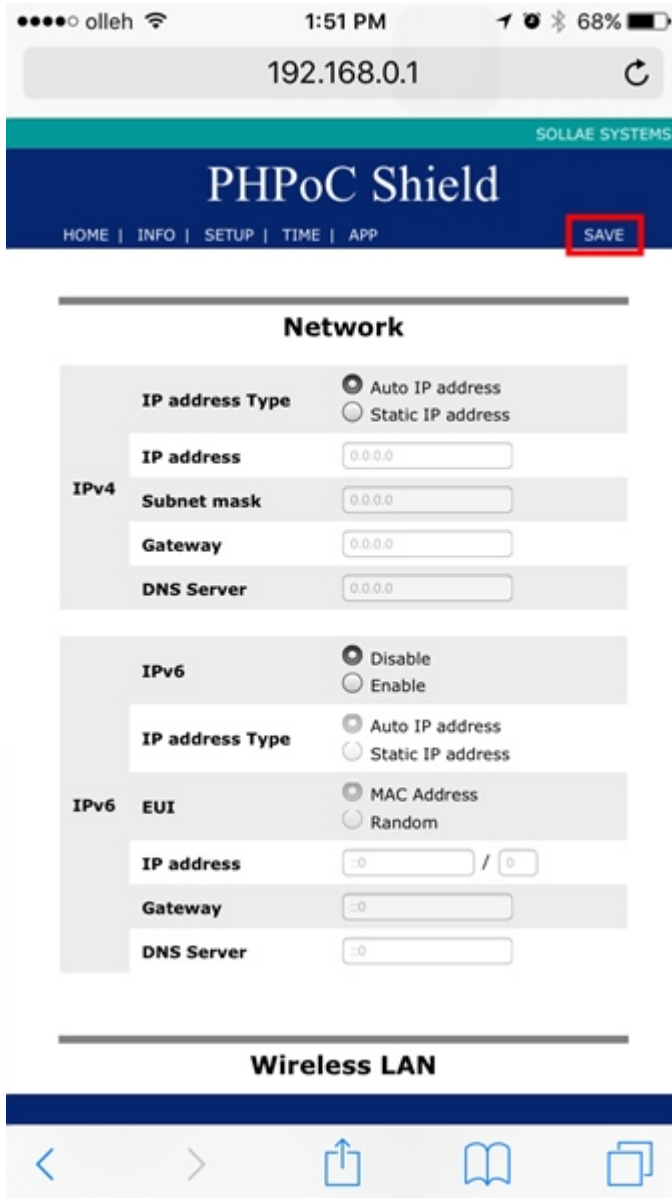

- Once the setup is completed, it will be automatically assigned with an IP address after rebooting.

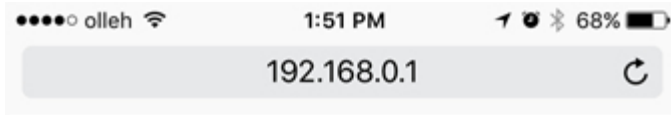

IP address may be changed. Please check newly assigned IP address from PHPoC Debugger and reconnect to the device.

setup complete

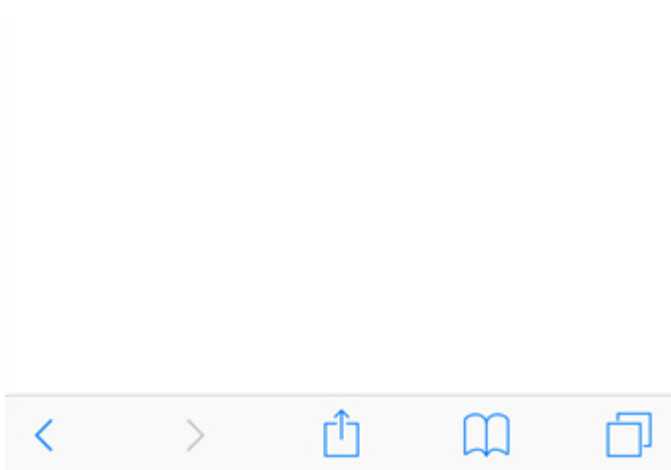

- To confirm the assigned IP address, follow the instructions from [Verify the IP Address](#).

Manual IP Address Setup

1. Connect to Web setup page of PHPoC Shield for Arduino.

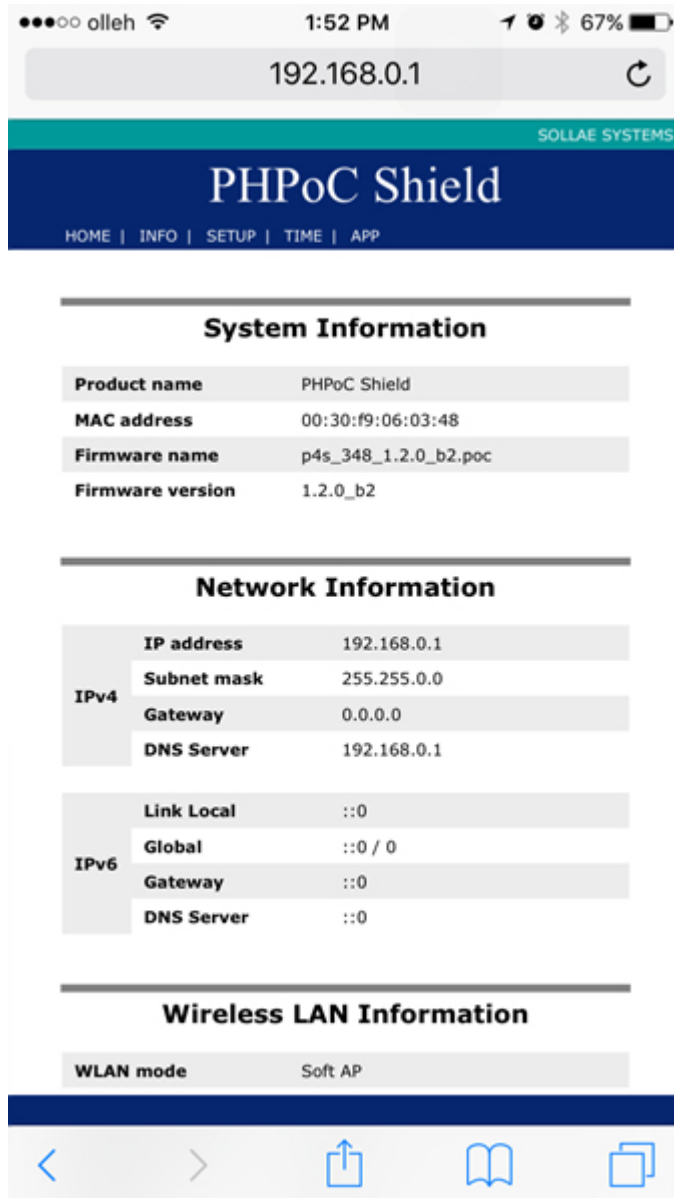

2. Move to SETUP page.

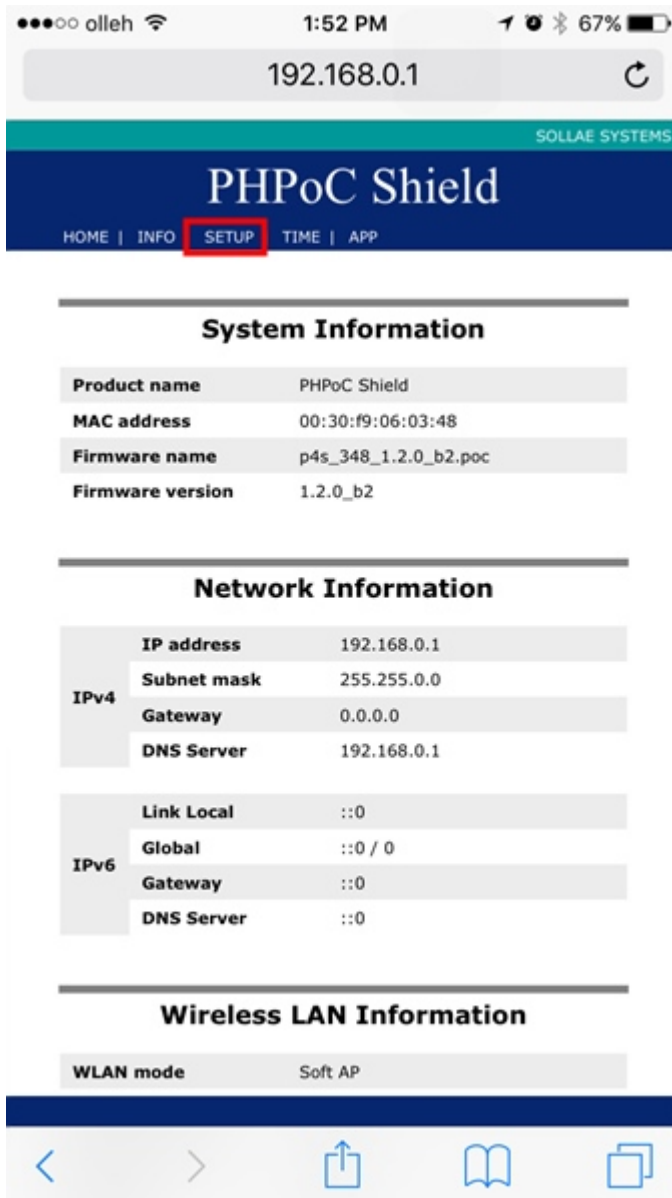

3. Select "Static IP Address" for IP Address Type.

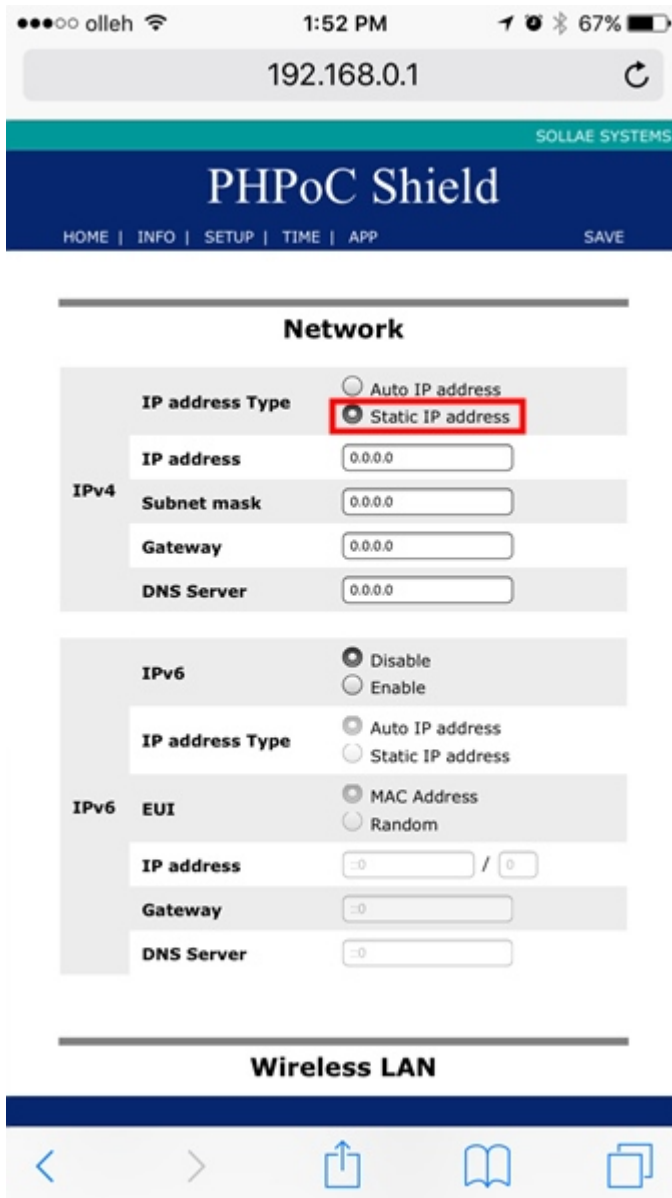

4. Input IP address, Subnet mask, Gateway IP address and DNS IP address.

The screenshot shows the 'Network' configuration screen for the PHPoC Shield. At the top, the status bar displays 'olleh', signal strength, Wi-Fi, time '1:53 PM', location, and battery '67%'. Below the status bar is a search bar containing '192.168.0.1'. The main header is 'PHPoC Shield' with 'SOLLAE SYSTEMS' in the top right. Navigation links 'HOME | INFO | SETUP | TIME | APP' and a 'SAVE' button are at the bottom of the header.

The 'Network' section is divided into two parts: IPv4 and IPv6.

IPv4 Settings (highlighted in red):

- IP address Type:** Auto IP address, Static IP address
- IP address:** 10.6.0.61
- Subnet mask:** 255.255.0.0
- Gateway:** 10.6.0.1
- DNS Server:** 10.6.0.1

IPv6 Settings:

- IPv6:** Disable, Enable
- IP address Type:** Auto IP address, Static IP address
- EUI:** MAC Address, Random
- IP address:** :-0 / 0
- Gateway:** :-0
- DNS Server:** :-0

The bottom of the screen shows a navigation bar with icons for back, forward, share, book, and tabs.

The IP address must be unique within the network. If you connect the shield to a public network, please make sure whether IP address is already in use or not. If there is a manager in charge of IP address assignment in the environment, we recommend to get assistance from the manager.

5. Click the "SAVE" on the top right of the page.

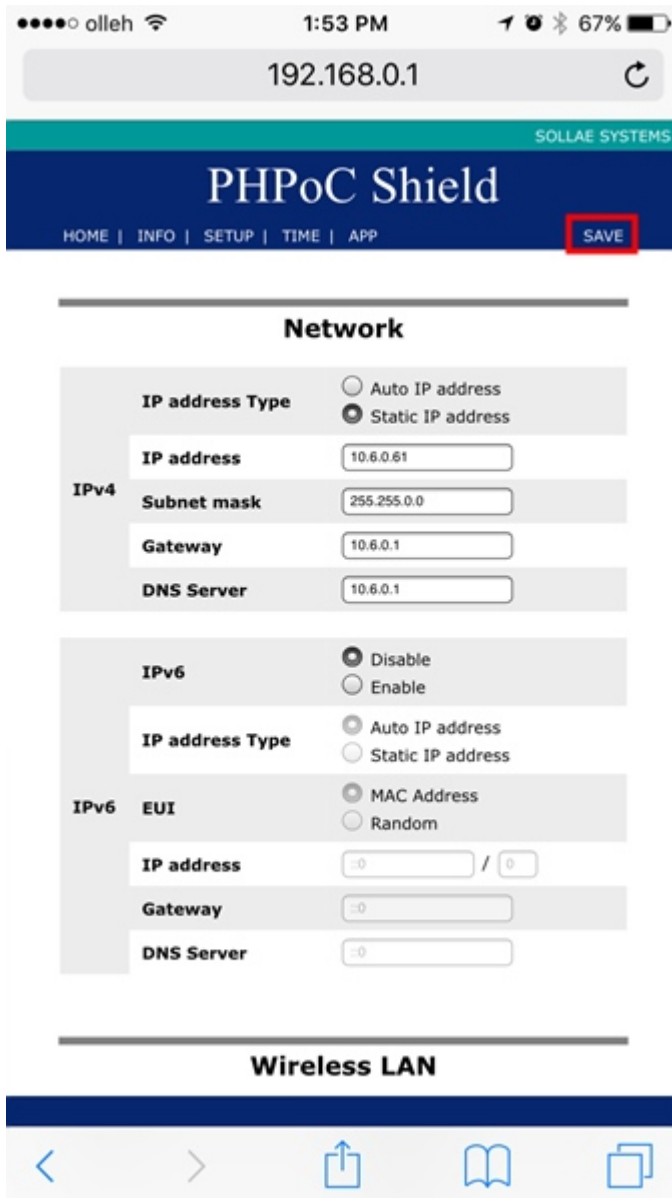

6. Once the setup is completed, the Web browser will be reconnected to its IP address.

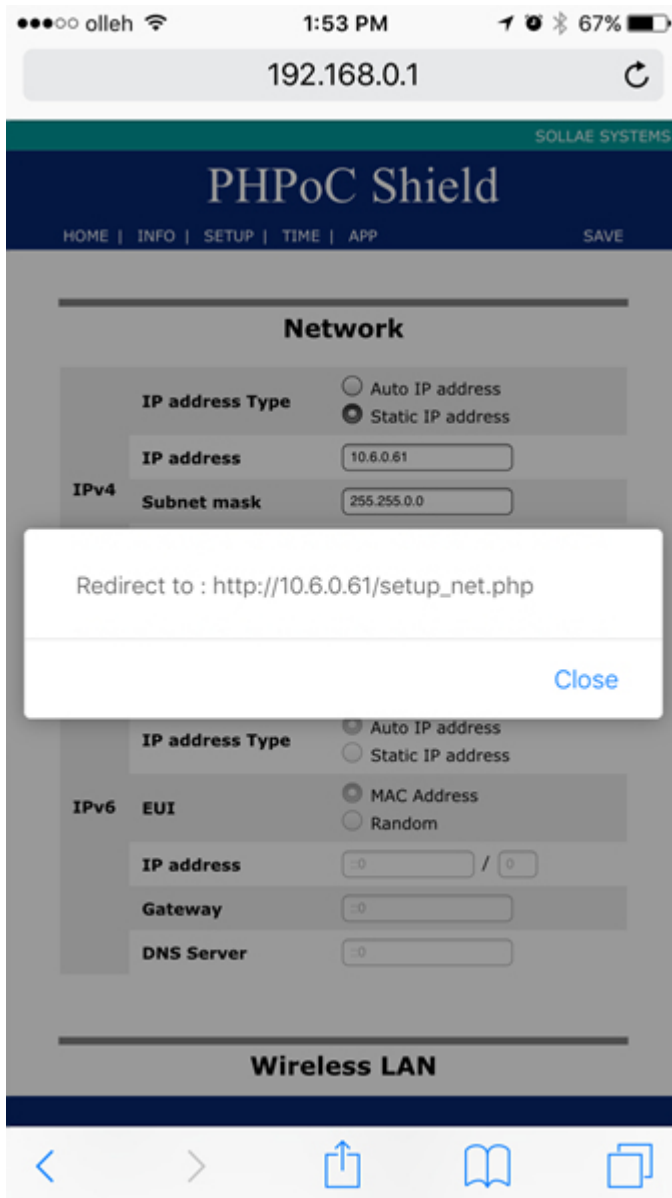

7. To confirm the assigned IP address, follow the instructions from [Verify the IP Address](#).

Verify the IP Address

1. Connect shield to the network according to the instruction from [Connecting to Network](#).
2. Input power to the Arduino and run the Arduino IDE.



3. Enter the following code in the Arduino IDE.

A screenshot of the Arduino IDE interface. The window title is "sketch_may03b | Arduino 1.7.9". The menu bar includes "File", "Edit", "Sketch", "Tools", and "Help". The toolbar contains icons for checkmark, play, grid, upload, download, and help. The main text area contains the following code:

```
sketch_may03b $
#include "SPI.h"
#include "Phpoc.h"

void setup() {
  Serial.begin(9600);
  while(!Serial)
    ;
  Phpoc.begin(PF_LOG_NET);
}

void loop() {
}
```

The status bar at the bottom shows "10" on the left and "Arduino Uno on COM3" on the right.

4. Upload the entered code on the Arduino.

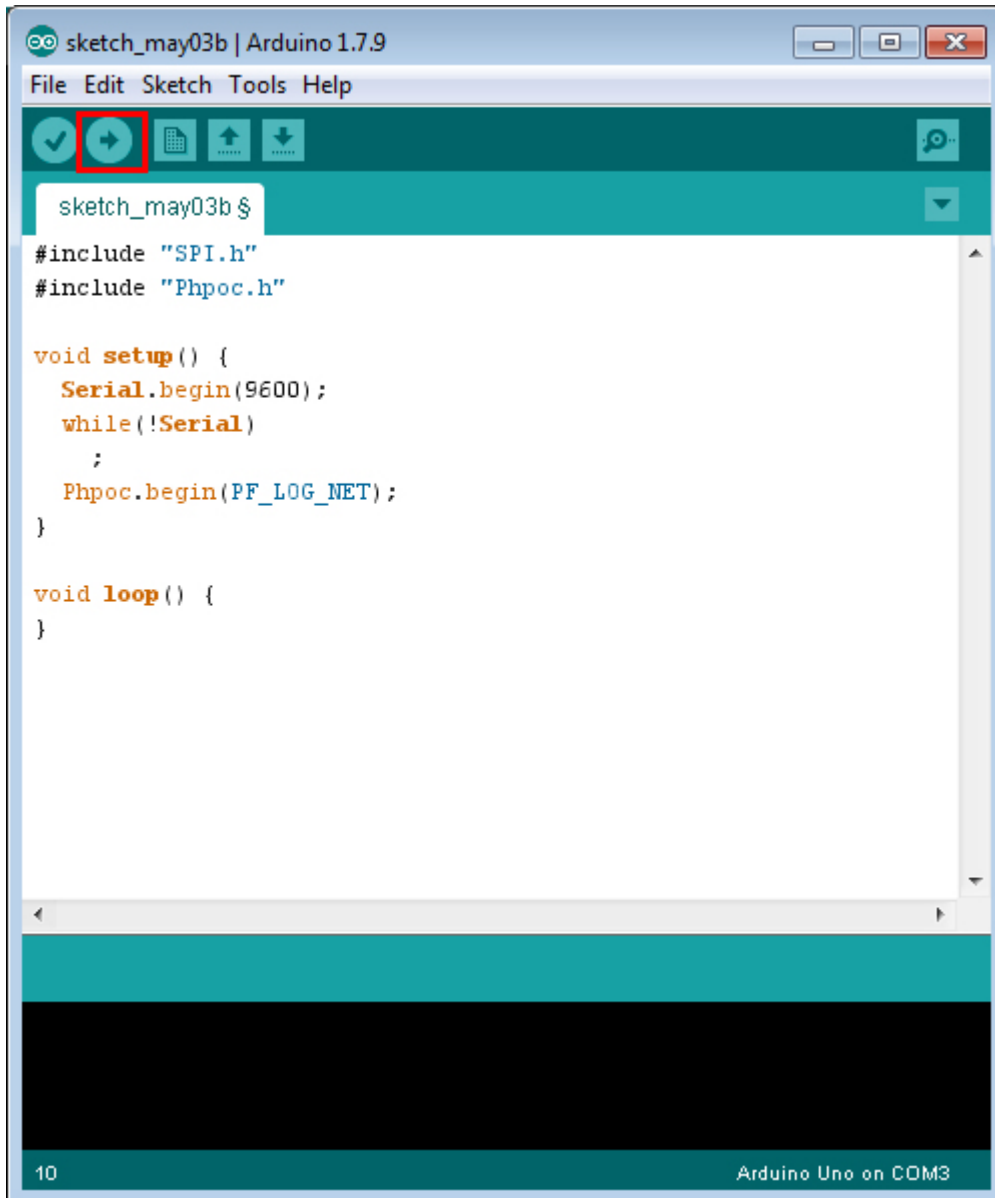

5. Click the serial monitor button of Arduino IDE.

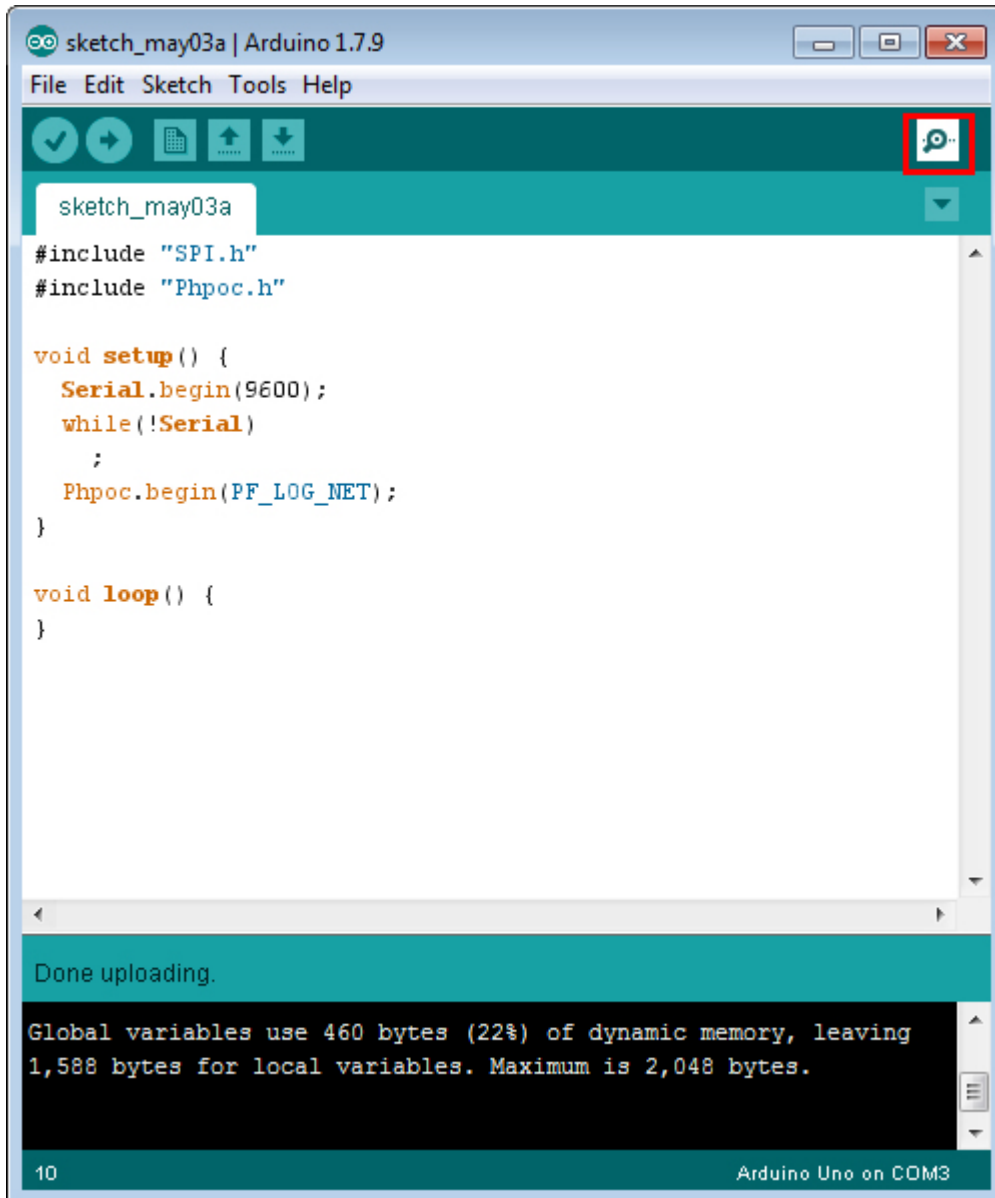

6. Verify the IP Address appearing on the serial monitor window.

- When the shield is connected to Ethernet

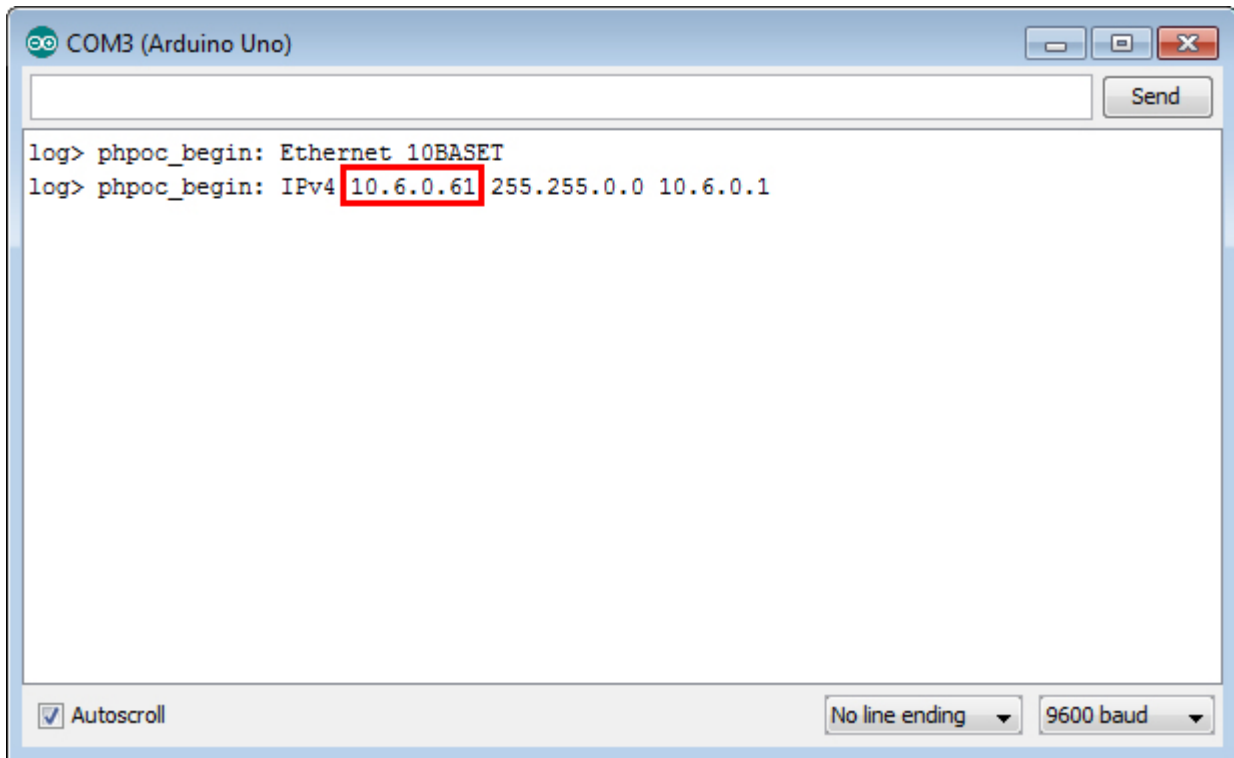

- When the shield is set to AP

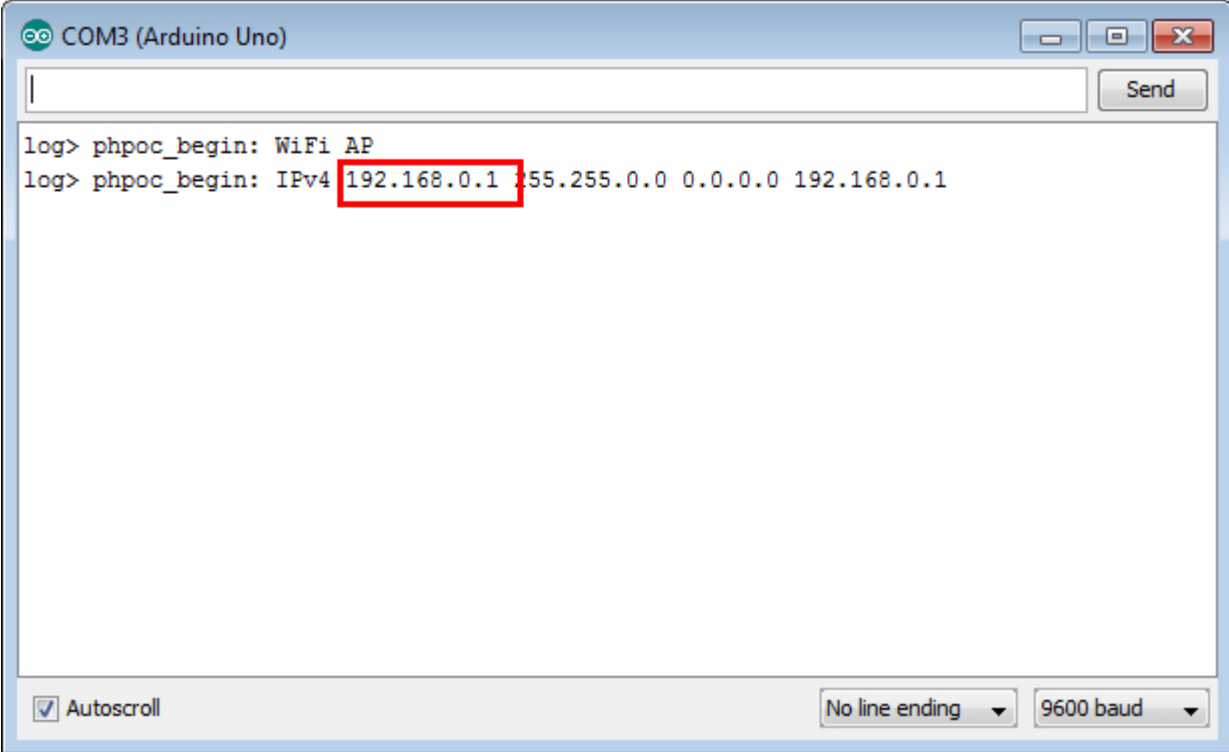

```
COM3 (Arduino Uno)
log> phpoc_begin: WiFi AP
log> phpoc_begin: IPv4 192.168.0.1 255.255.0.0 0.0.0.0 192.168.0.1
```

The screenshot shows a serial monitor window titled "COM3 (Arduino Uno)". The output text is: "log> phpoc_begin: WiFi AP" followed by "log> phpoc_begin: IPv4 192.168.0.1 255.255.0.0 0.0.0.0 192.168.0.1". The IP address "192.168.0.1" is highlighted with a red box. The window includes a "Send" button, an "Autoscroll" checkbox, and dropdown menus for "No line ending" and "9600 baud".

- When the shield is connected to a WLAN router or AP

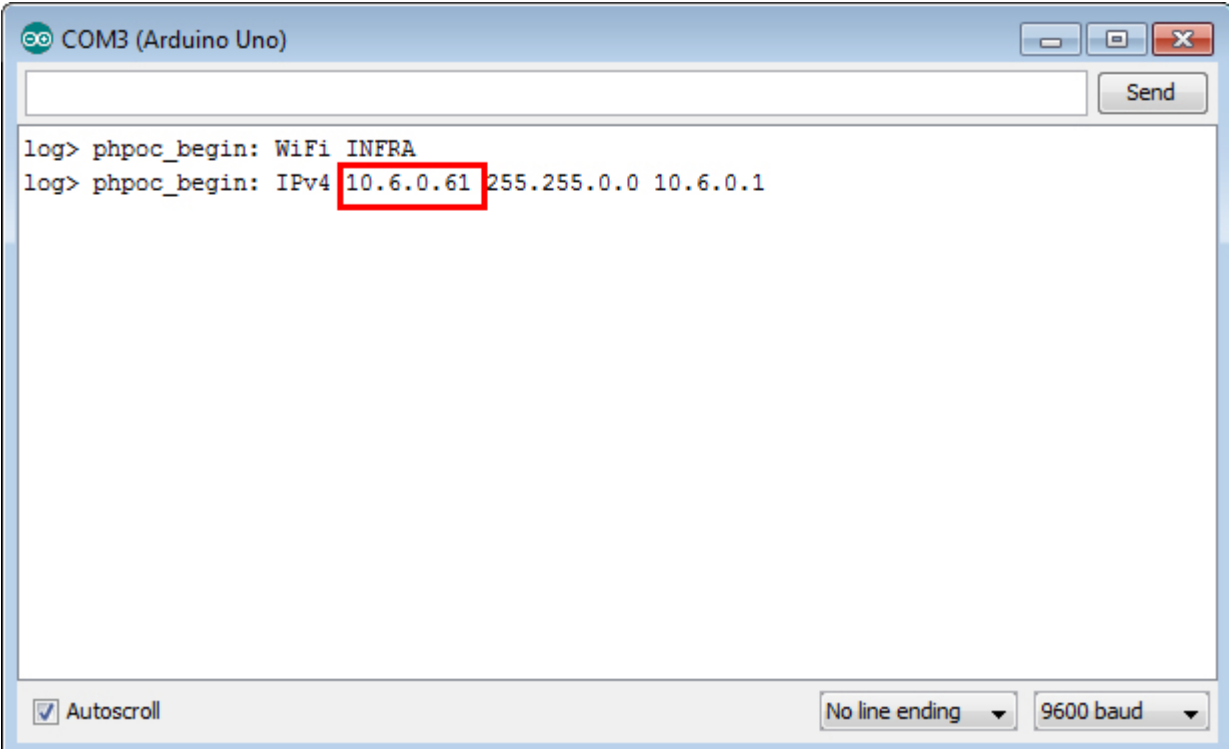

```
COM3 (Arduino Uno)
log> phpoc_begin: WiFi INFRA
log> phpoc_begin: IPv4 10.6.0.61 255.255.0.0 10.6.0.1
```

The screenshot shows a serial monitor window titled "COM3 (Arduino Uno)". The output text is: "log> phpoc_begin: WiFi INFRA" followed by "log> phpoc_begin: IPv4 10.6.0.61 255.255.0.0 10.6.0.1". The IP address "10.6.0.61" is highlighted with a red box. The window includes a "Send" button, an "Autoscroll" checkbox, and dropdown menus for "No line ending" and "9600 baud".

Library Overview

PHPoC Shield for Arduino provides Phpoc Library so users can easily access a variety of functions, including basic network communications capabilities. With Phpoc Library you can easily implement the following functions:

- TCP client
- TCP Server: SSL, SSH, Telnet and Websocket Server
- E-mail
- Date and time information inquiry

TCP or websocket server allows up to four clients to simultaneous connect. However, if it is SSL or SSH server, it only allows one client for each.

Installing the Library

1. Run Arduino IDE.



2. Click the Sketch > Include Library > Manage Libraries.. menu.

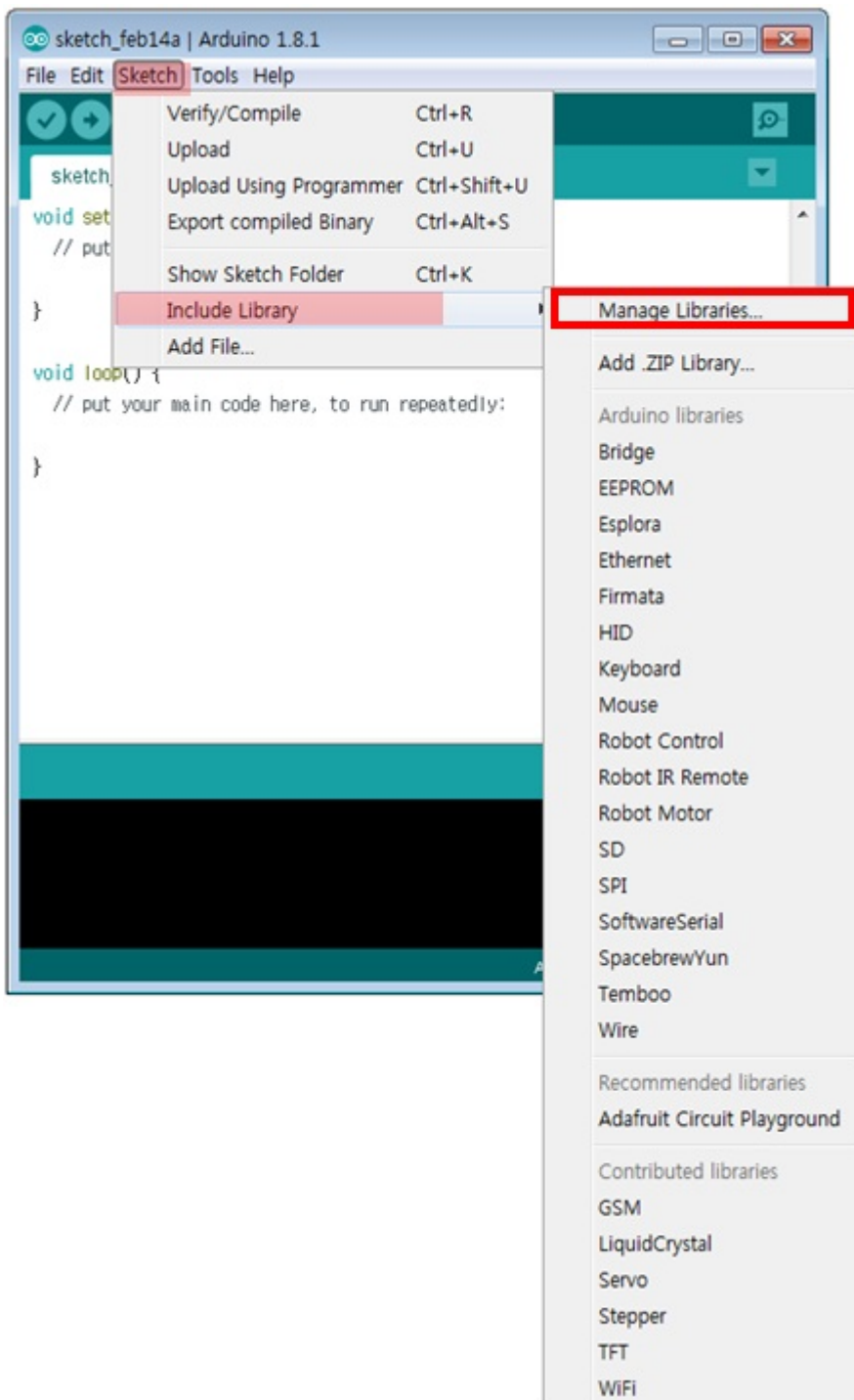

3. Search "phpoc" on the Library Manager.

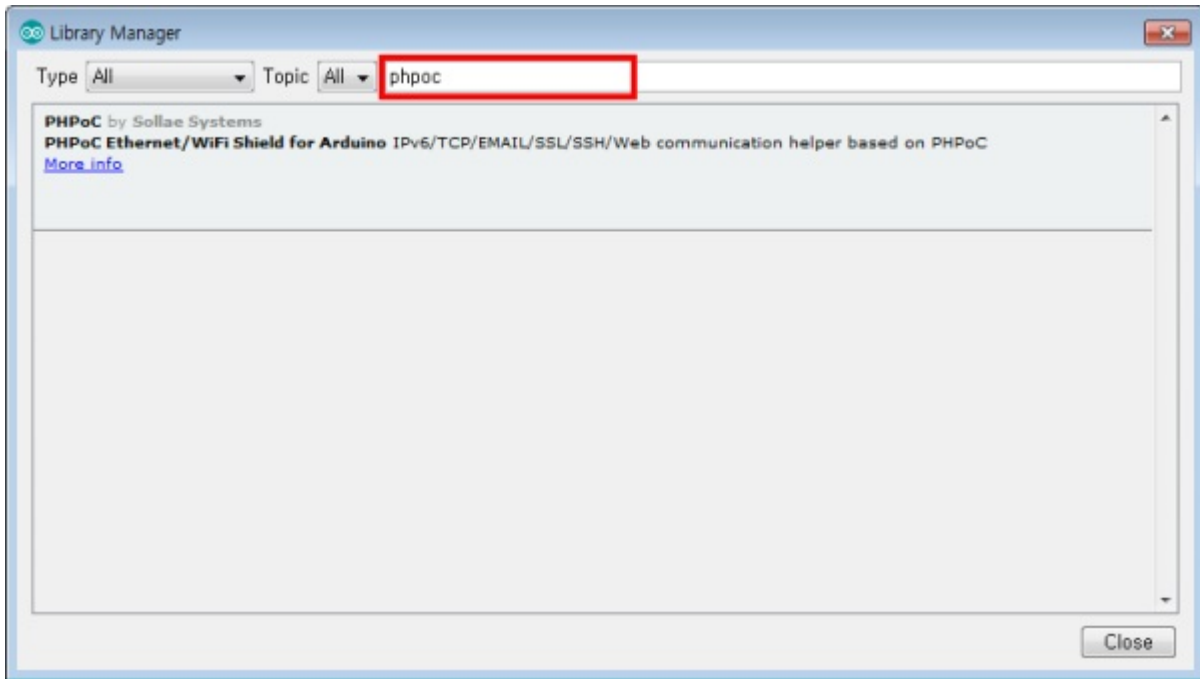

4. Select the PHPoC library and press the [Install] button.

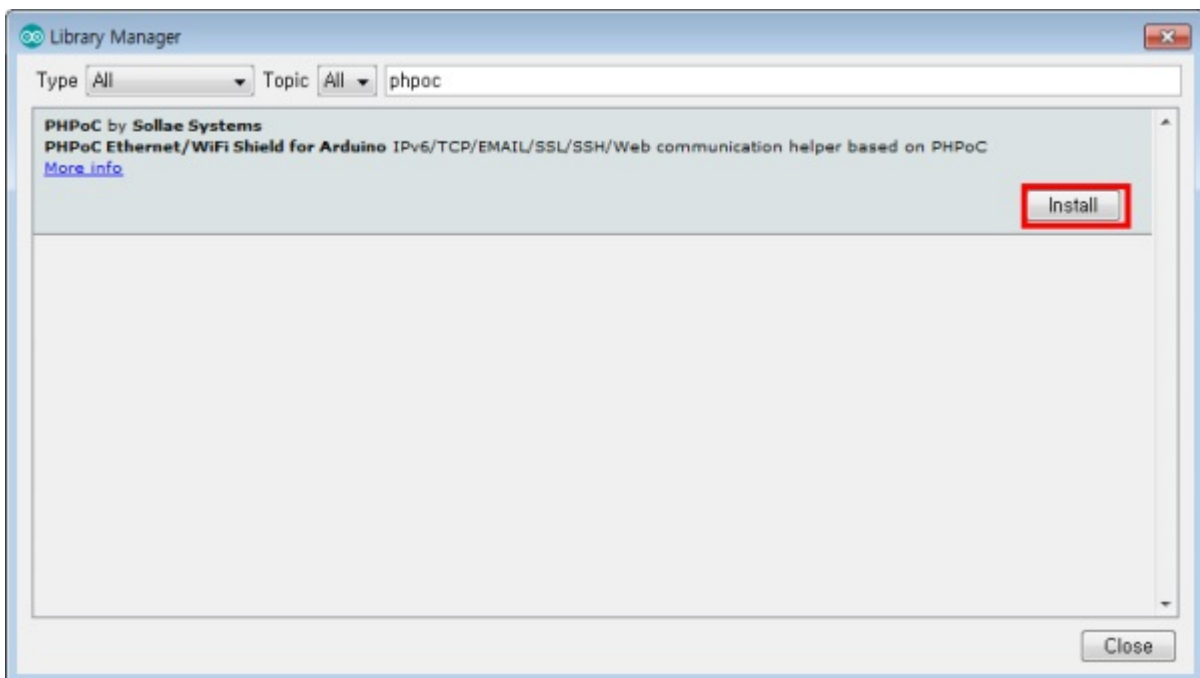

"INSTALLED" message will appear on success.

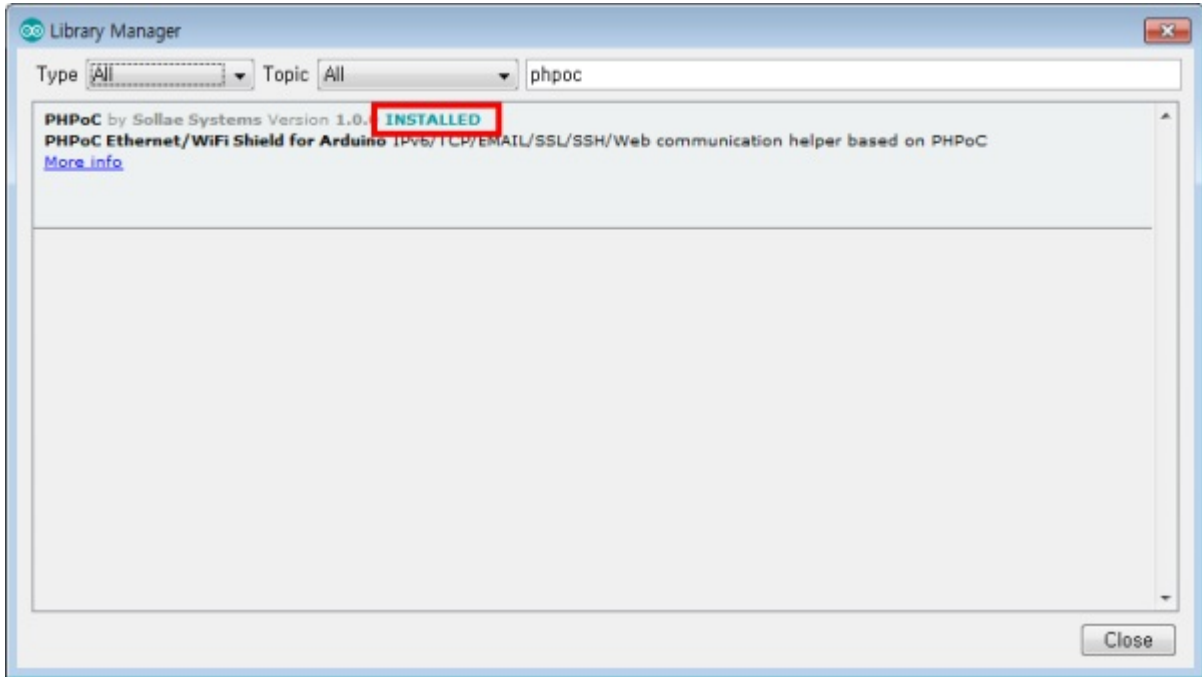

5. Confirm the additional Arduino Ph poc Library.

Check if "PHPoC" has been added to the "Include Library" menu of the sketch menu of Arduino IDE.

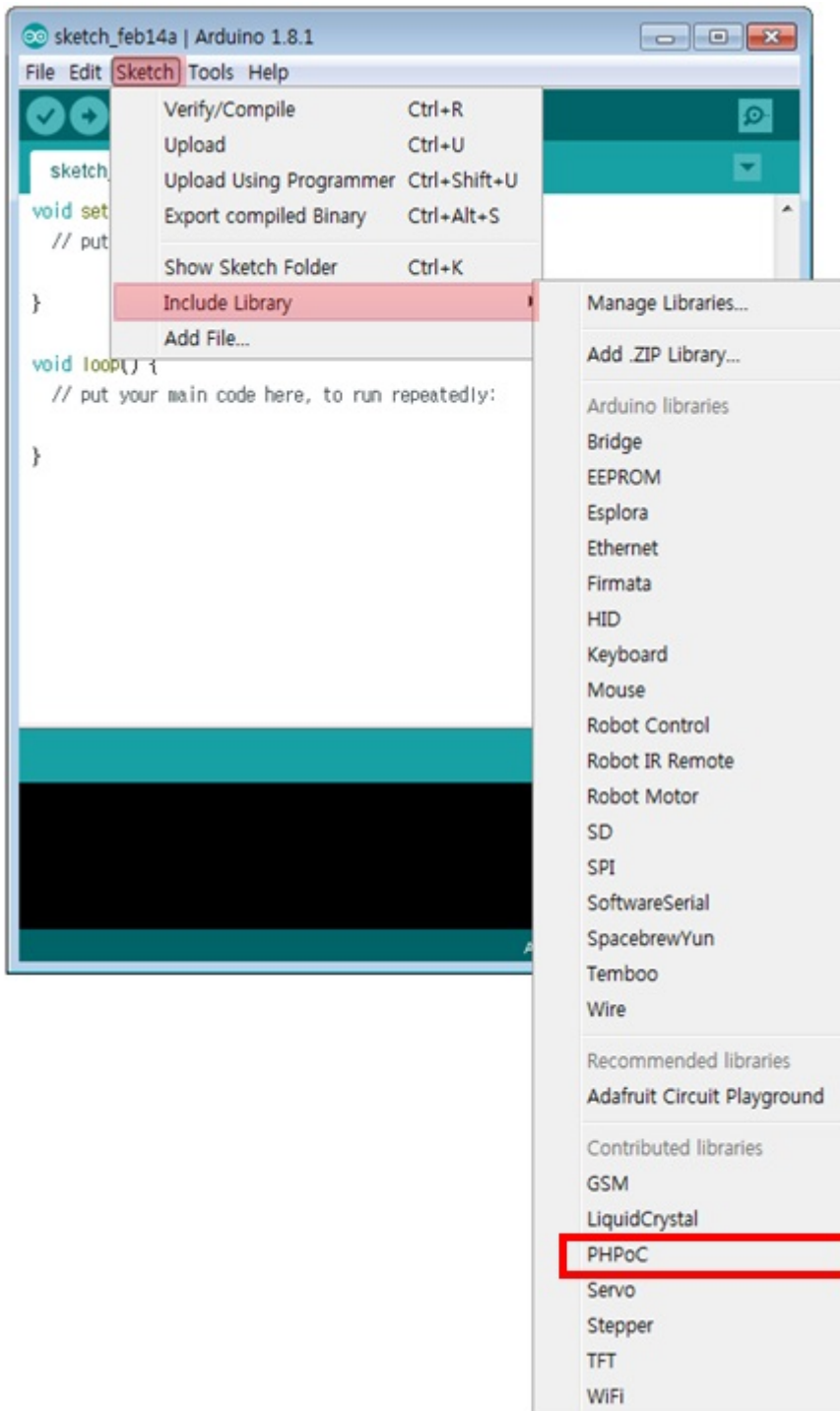

6. Confirm the additional Arduino PHPoC examples.

Check if "PHPoC" has been added to the "Examples" menu in the file menu of Arduino IDE.

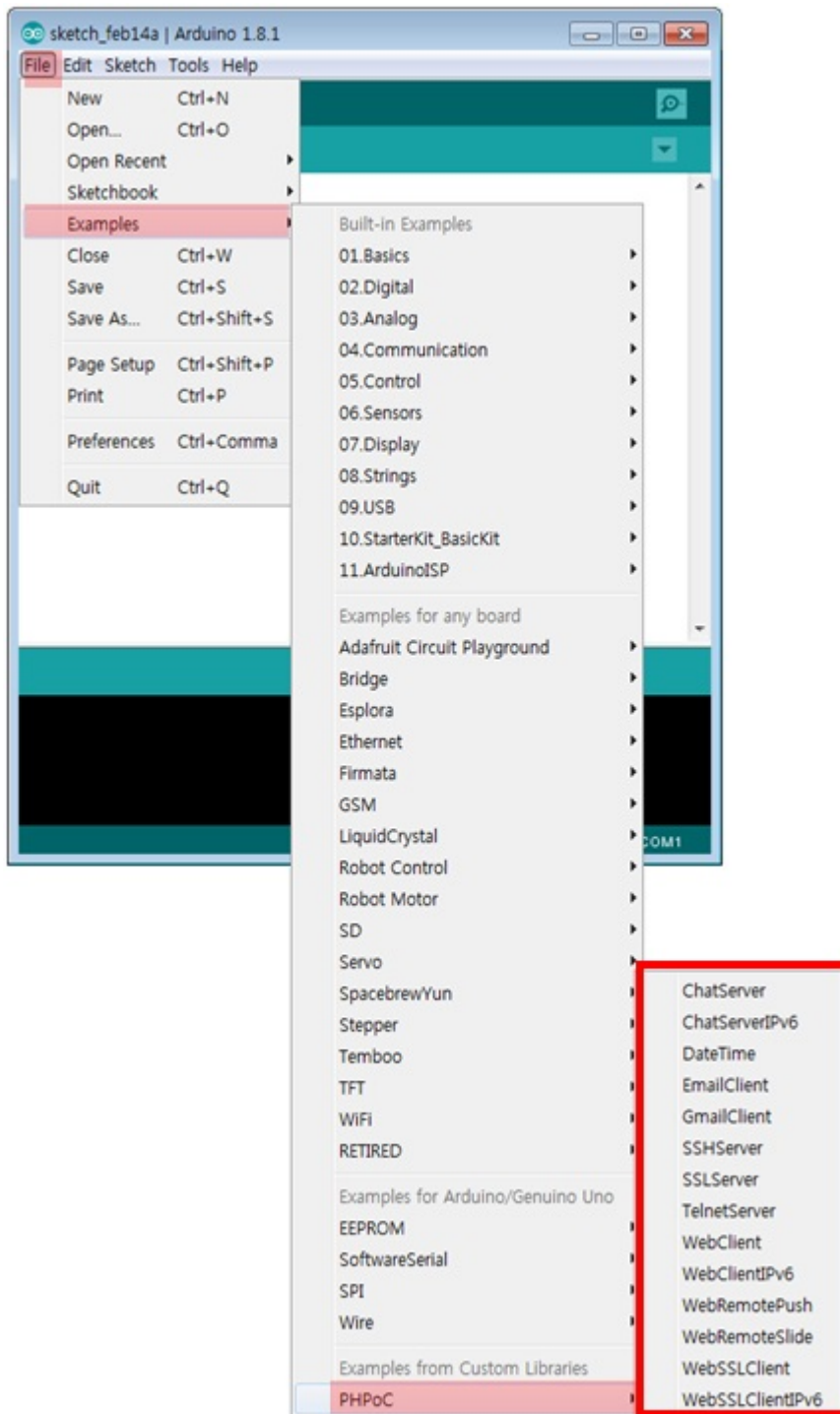
7. To run the built-in examples of PHPoC Shield, follow the instructions from [Run the Example](#).

Run the Examples

Examples included in the Arduino Phpoc Library can be loaded and run directly from Arduino IDE. Here is the procedure for running the Chat Server examples.

1. Install the Phpoc Library through [Installing The Library](#).
2. Run the Arduino IDE and select ChatServer in the File> Examples > Phpoc menu.

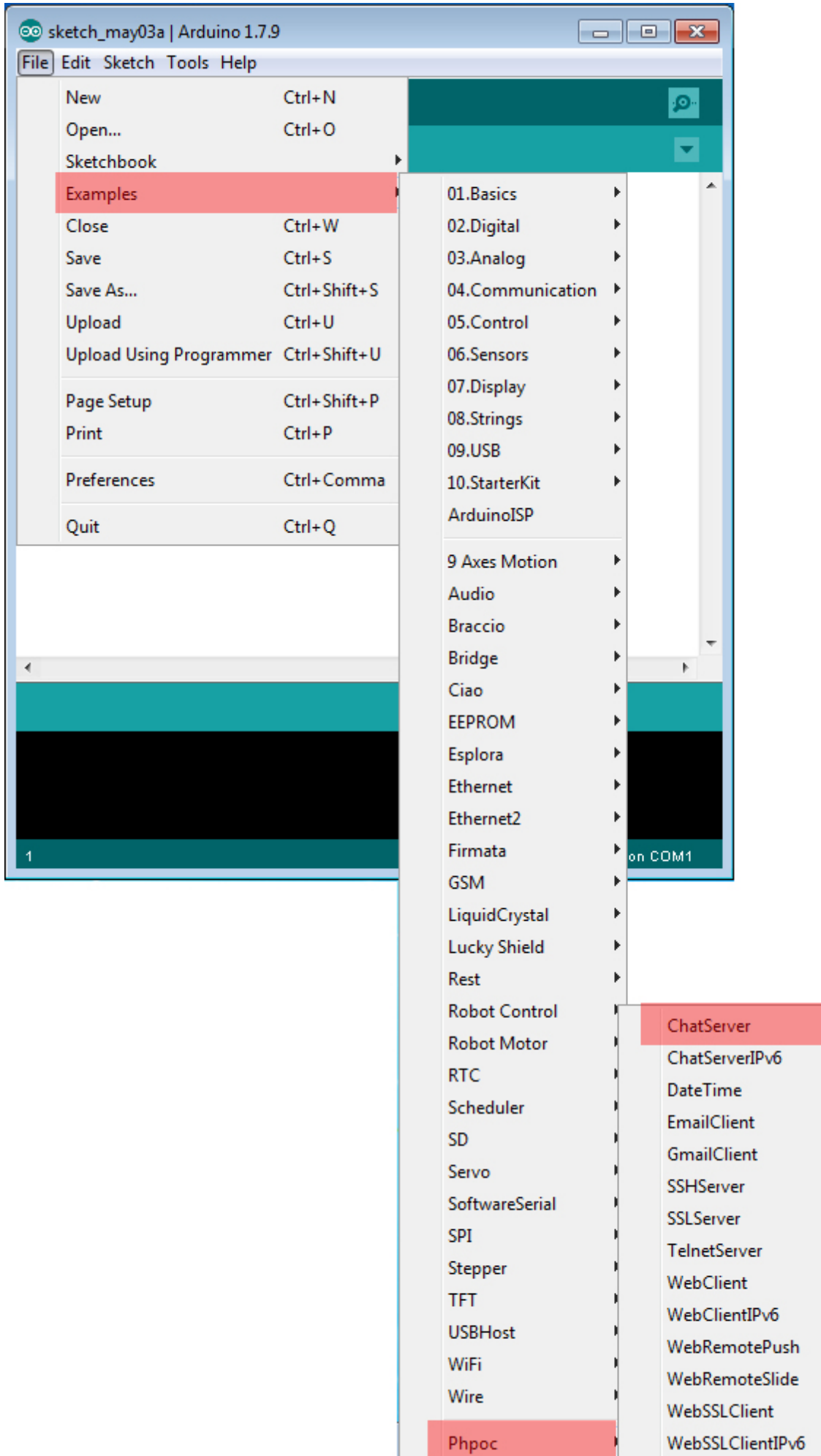

3. Upload the example code to the Arduino via "Check (compile)" and "Upload" button.

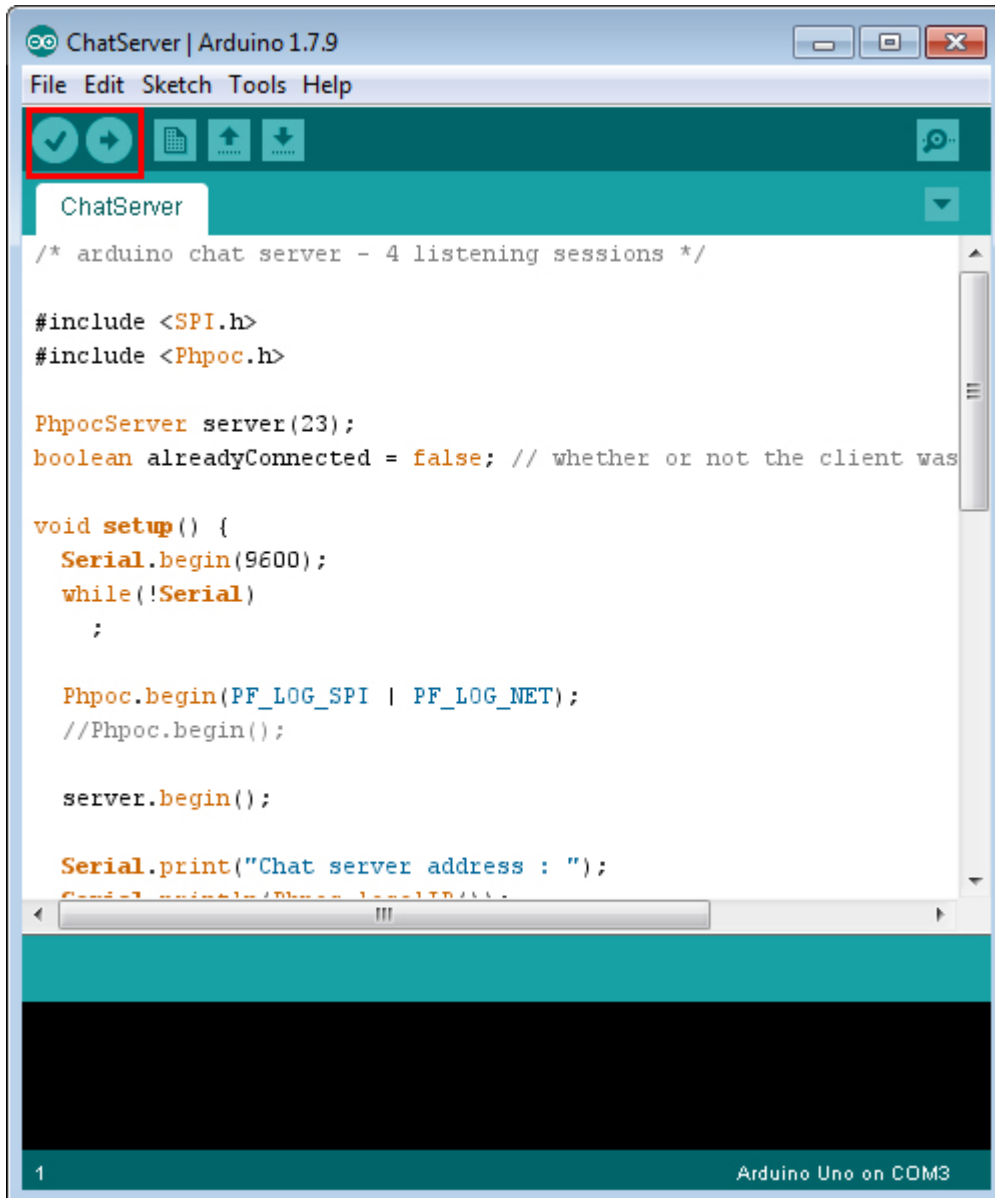

4. When the upload is complete, click the Serial Monitor icon.

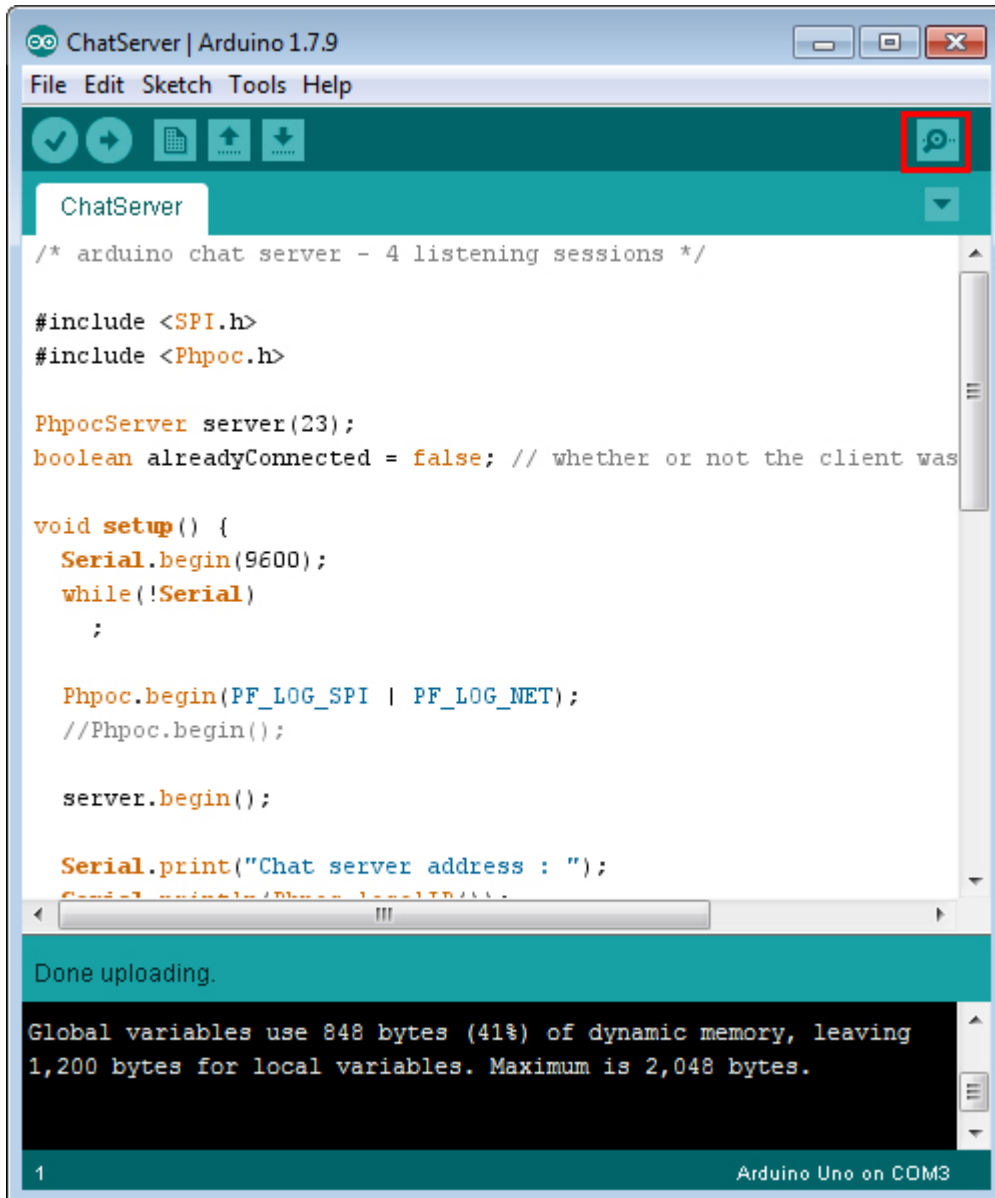

5. Check the execution results of the serial monitor window.

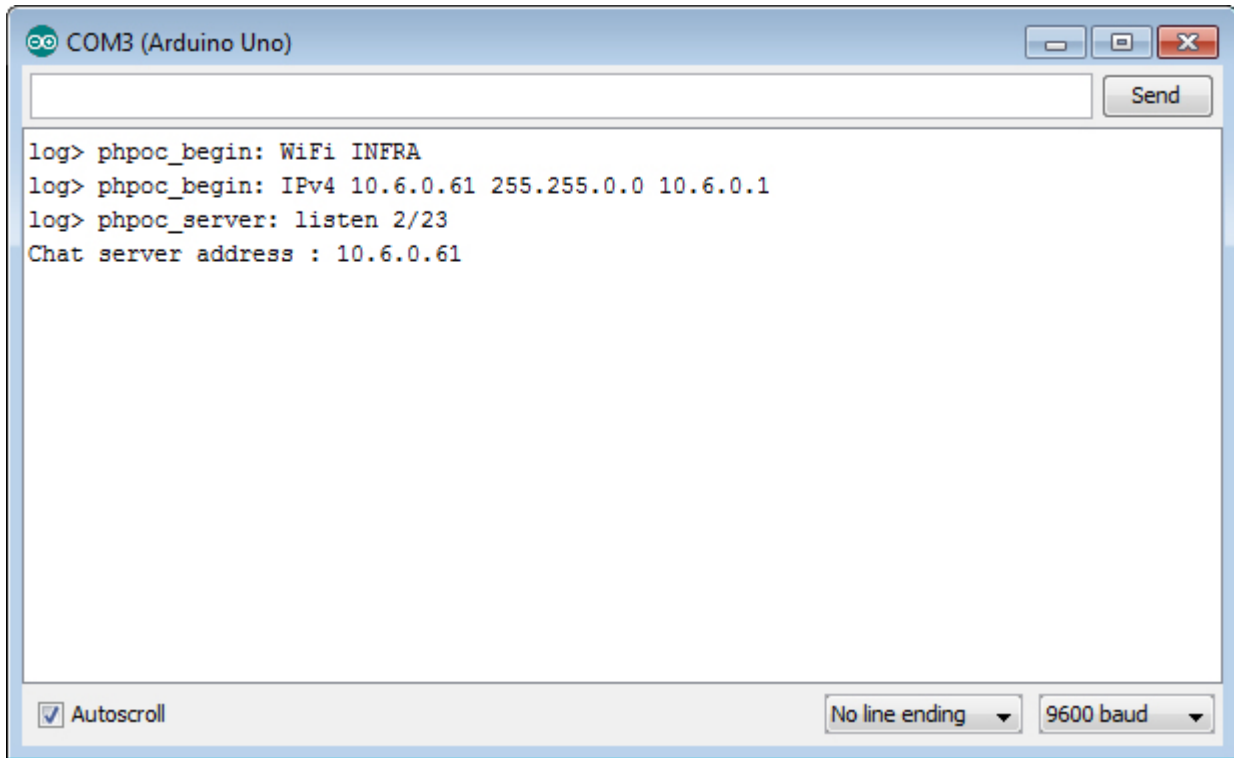

```
log> phpoc_begin: WiFi INFRA
log> phpoc_begin: IPv4 10.6.0.61 255.255.0.0 10.6.0.1
log> phpoc_server: listen 2/23
Chat server address : 10.6.0.61
```

The Phpoc Library includes various examples using E-mail transmission, SSL communications, SSH communications and Websockets. Try to use more examples in accordance with the above procedure.

Web Serial Monitor

Serial Monitor is provided by Arduino IDE and can be used to debug source codes or to output the results. PHPoC Shield for Arduino provides the same function with the serial monitor via web. With your smartphone, you can operate whenever or wherever without connecting Arduino to the PC because of its web-based features.

After finishing the steps below, try modifying this example to monitor values from sensors.

Using Web Serial Monitor

1. Connect the shield to the network according to [Connecting to Network](#).
2. Install Phpoc Library on your PC according to [Installing the Library](#).
3. Run the Arduino IDE from the PC.



4. Open the "DateTime" example to confirm the web serial monitor feature.

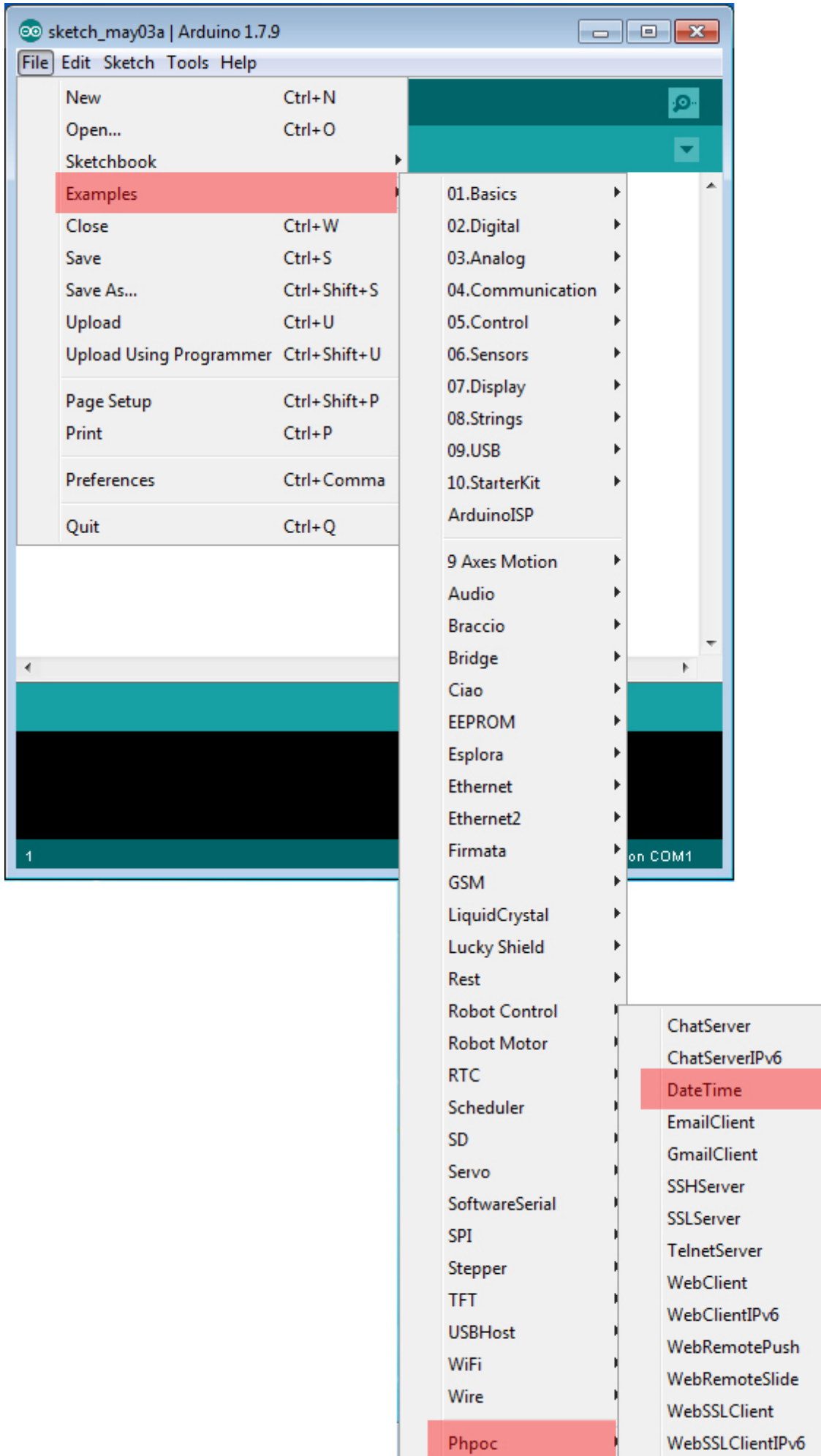

5. After checking the loaded examples, upload them to the Arduino.

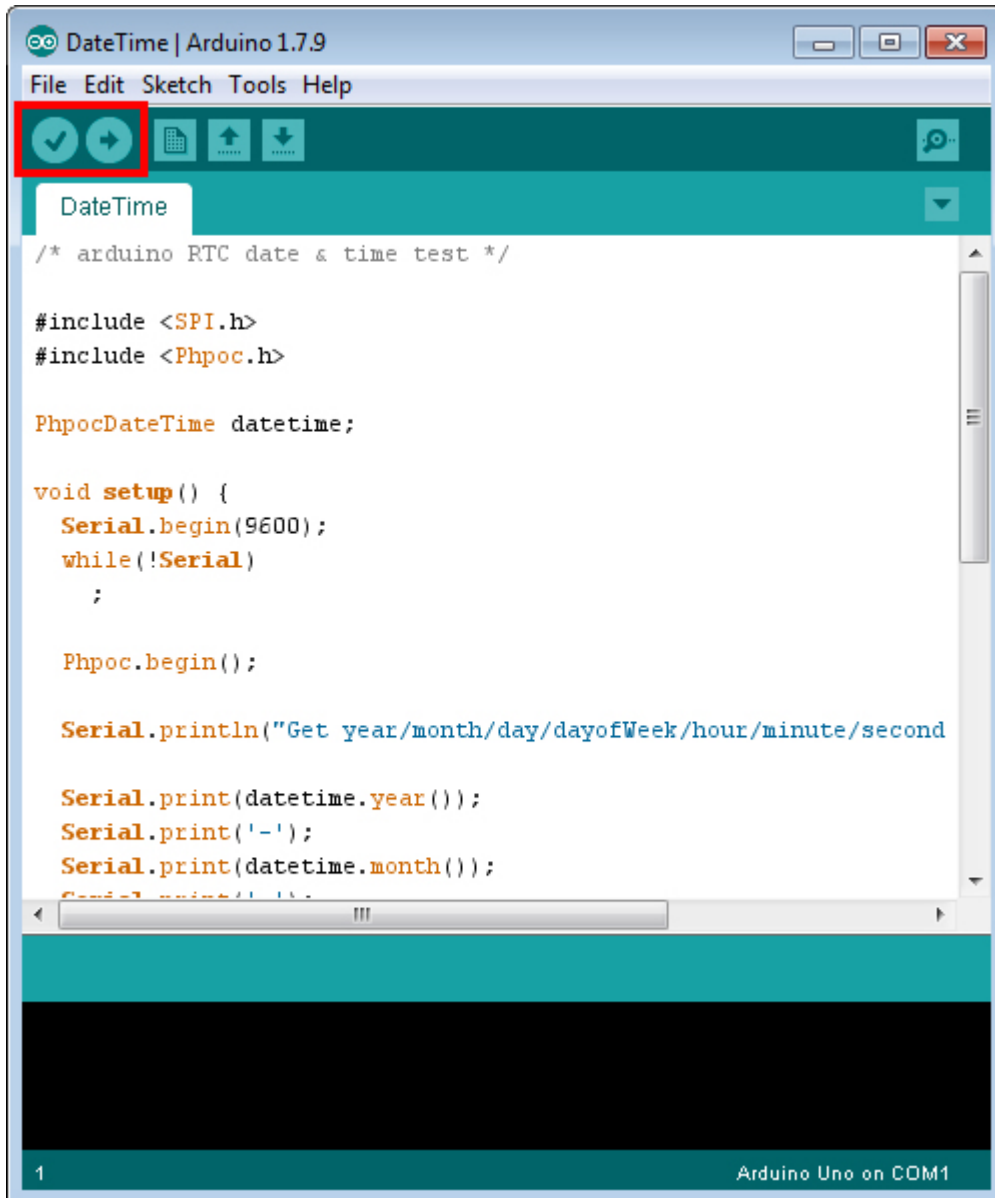

- Now run a web browser on your smartphone or PC and connect to the IP address of the shield.



Please, check [Verify The IP Address](#) if you do not know the IP address.

7. Click "Web Serial Monitor".



8. Set the rate to "9600" and click "Connect".



- Once it is successfully connected, it will output the date and time as shown in the serial monitor.



10. Click on the button in the serial monitor of Arduino IDE, you can see the same output.

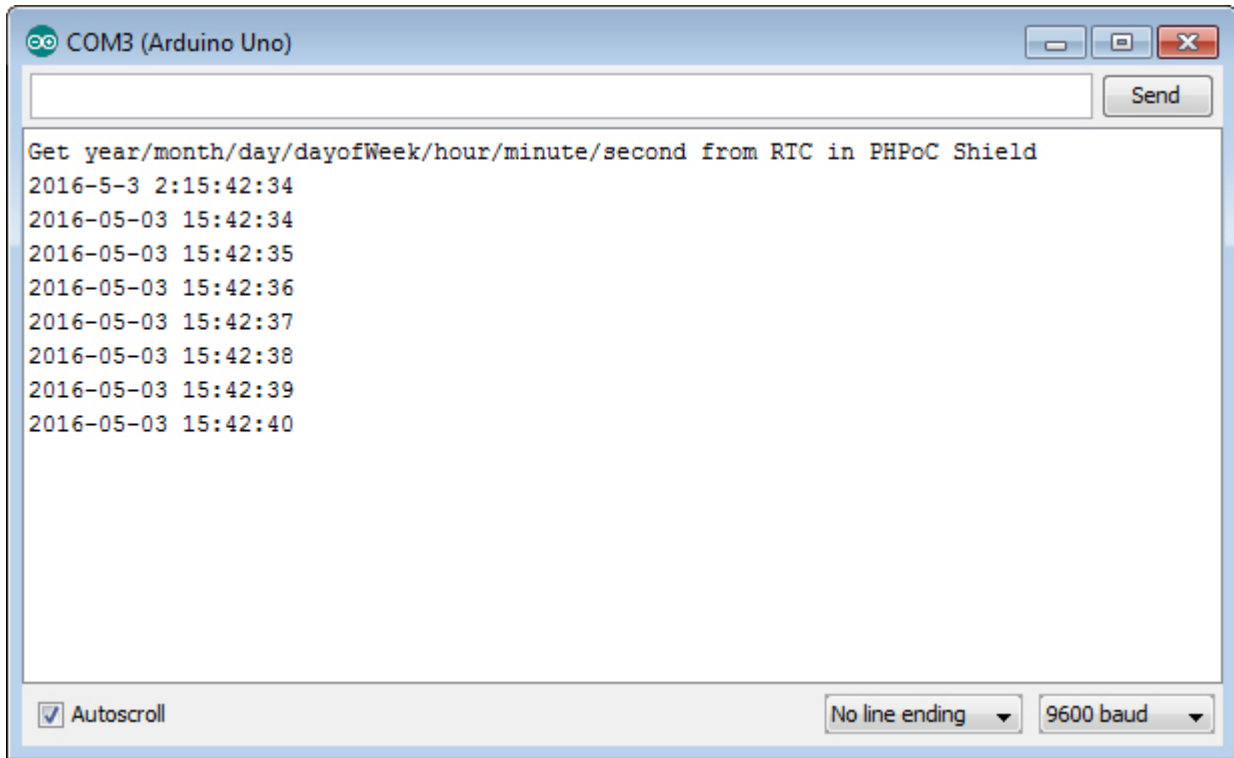

Web Remote Control (Push)

Using the web remote control, you can control Arduino remotely by sending specific data to the Arduino on the Web. PHPoC Shield for Arduino provides the ability to send data to the Arduino using buttons on the Web.

After finishing the steps below, try modifying this example to control LED, motor or other devices.

Using the Web Remote Control (Push)

1. Connect the shield to the network according to [Connecting to Network](#).
2. Install Phpoc Library to your PC according to [Installing The Library](#).
3. Run the Arduino IDE from the PC.



4. Open the "WebRemotePush" example.

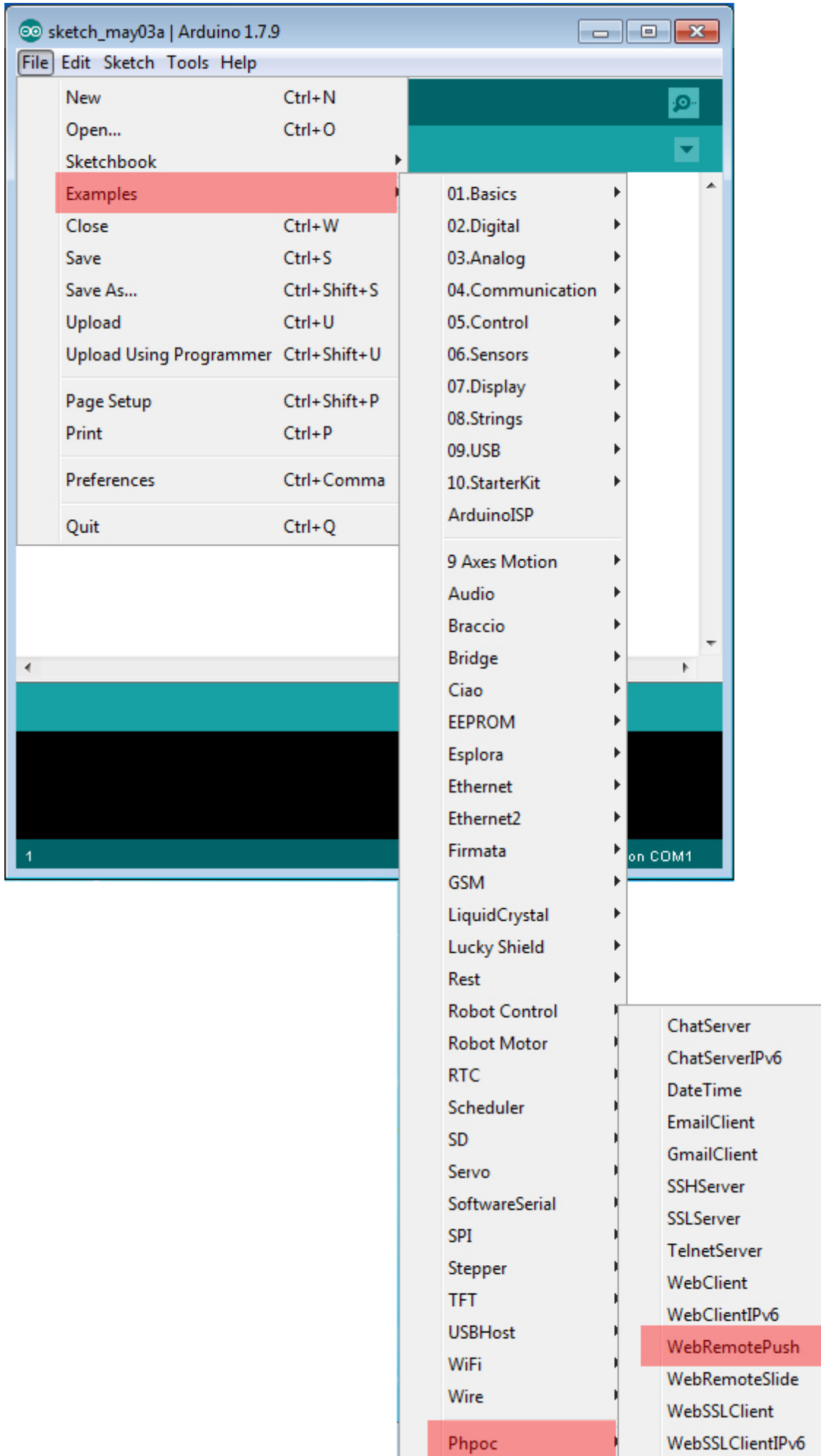

5. Check and upload the example to the Arduino.

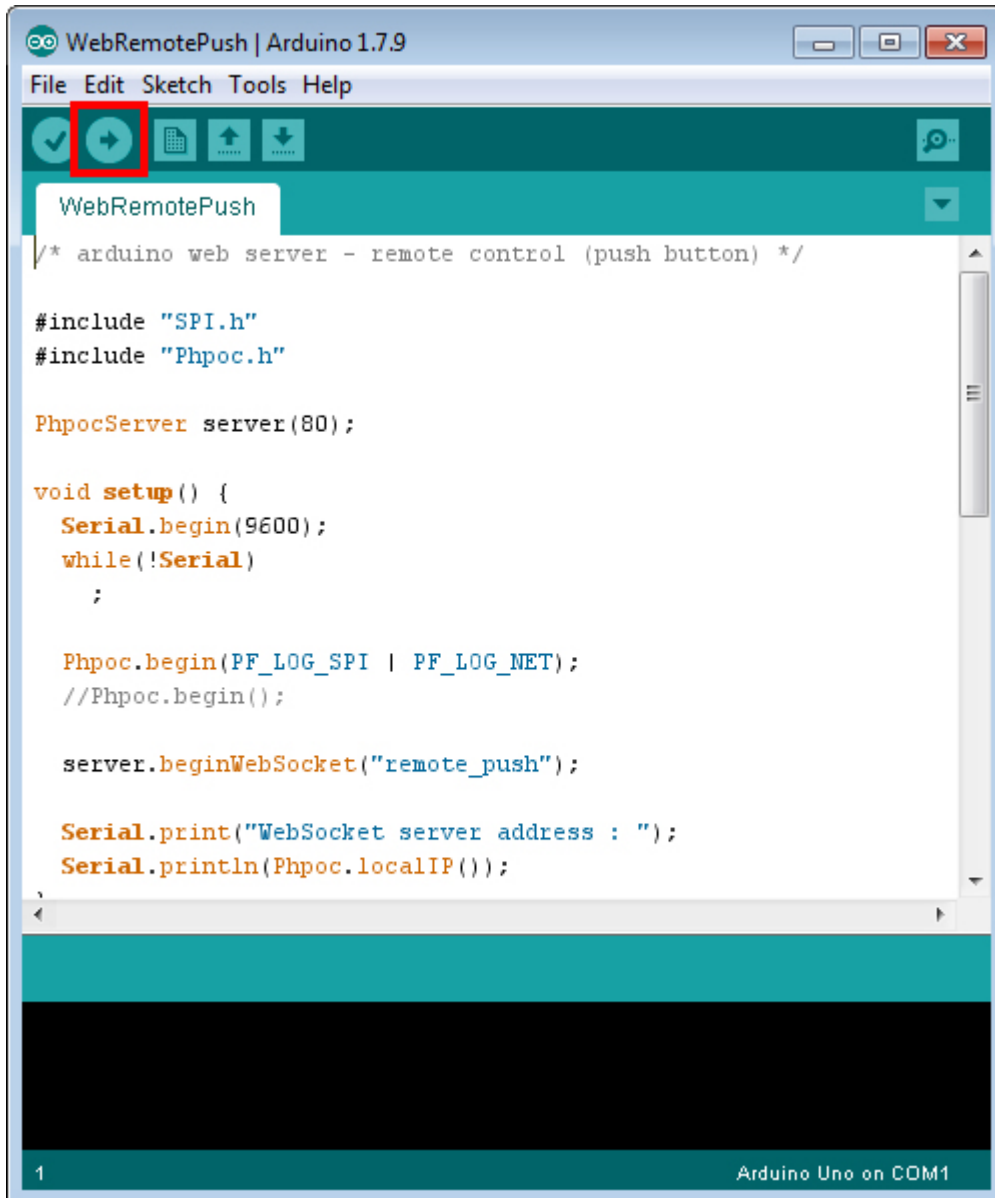

6. Click the serial monitor of Arduino IDE.

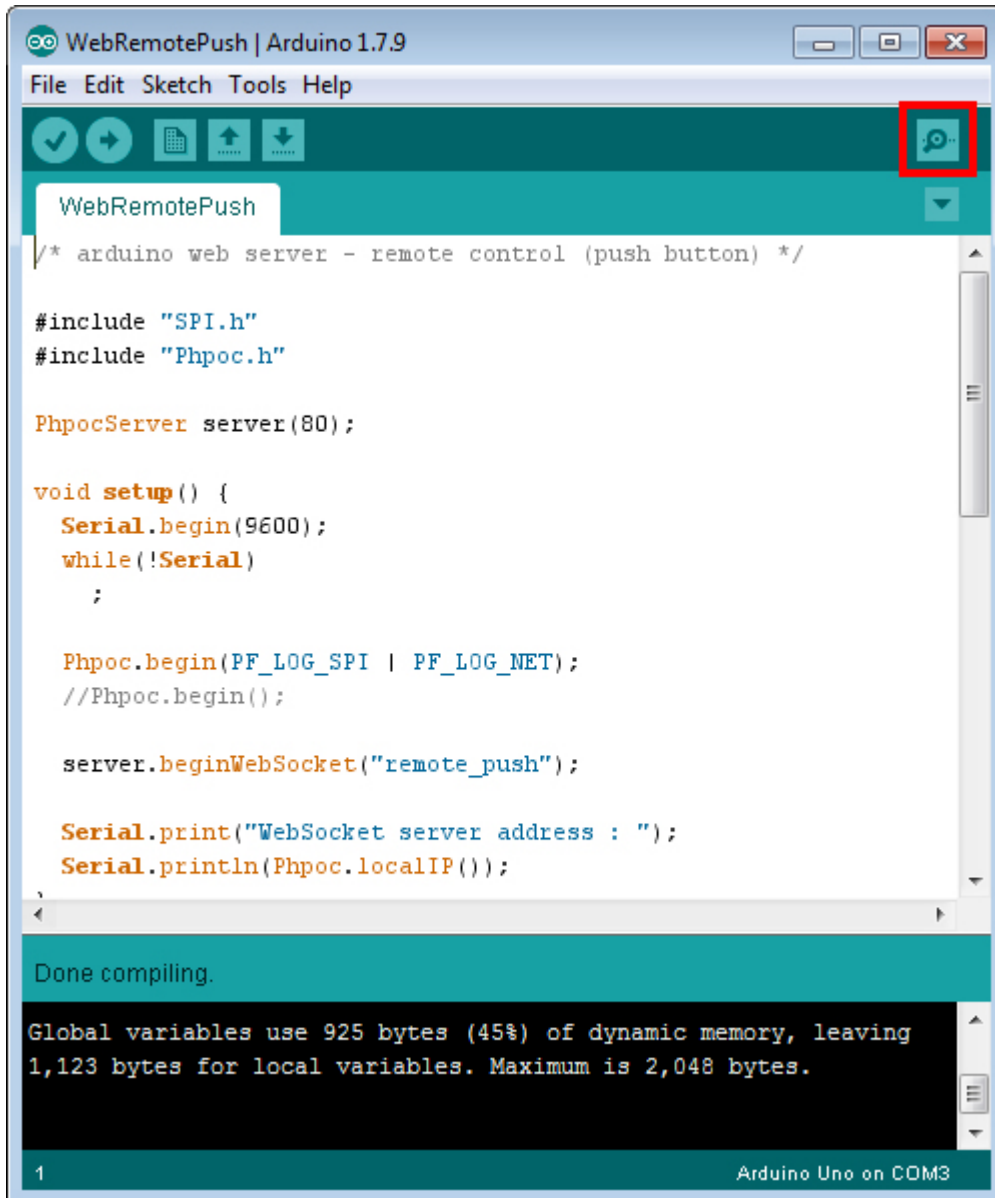

7. Check the IP address of the shield and leave the windows open.

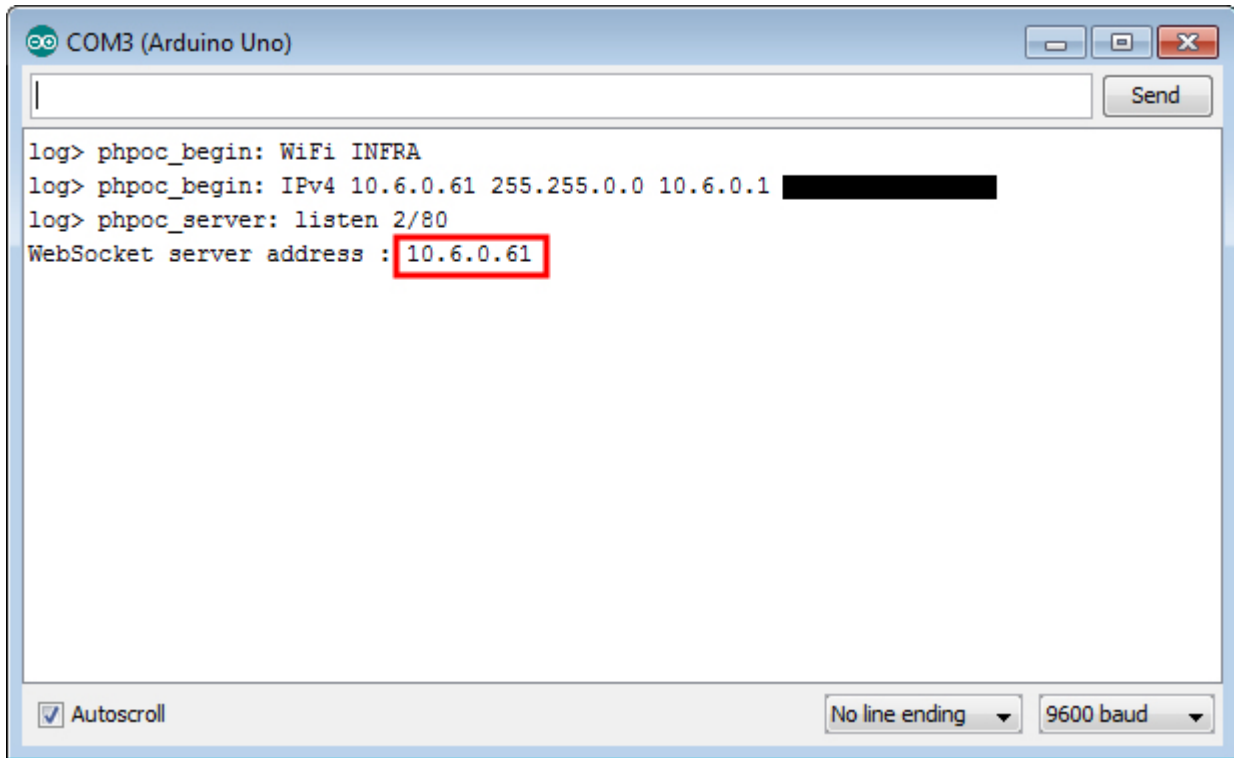

```
COM3 (Arduino Uno)
|
|
log> phpoc_begin: WiFi INFRA
log> phpoc_begin: IPv4 10.6.0.61 255.255.0.0 10.6.0.1 [REDACTED]
log> phpoc_server: listen 2/80
WebSocket server address : 10.6.0.61
|
|
 Autoscroll
No line ending
9600 baud
```

8. Now run a web browser on your smartphone or PC and connect to the IP address of the shield.



9. Click "Web Remote Control / Push".



10. Click "Connect" to connect to the shield.

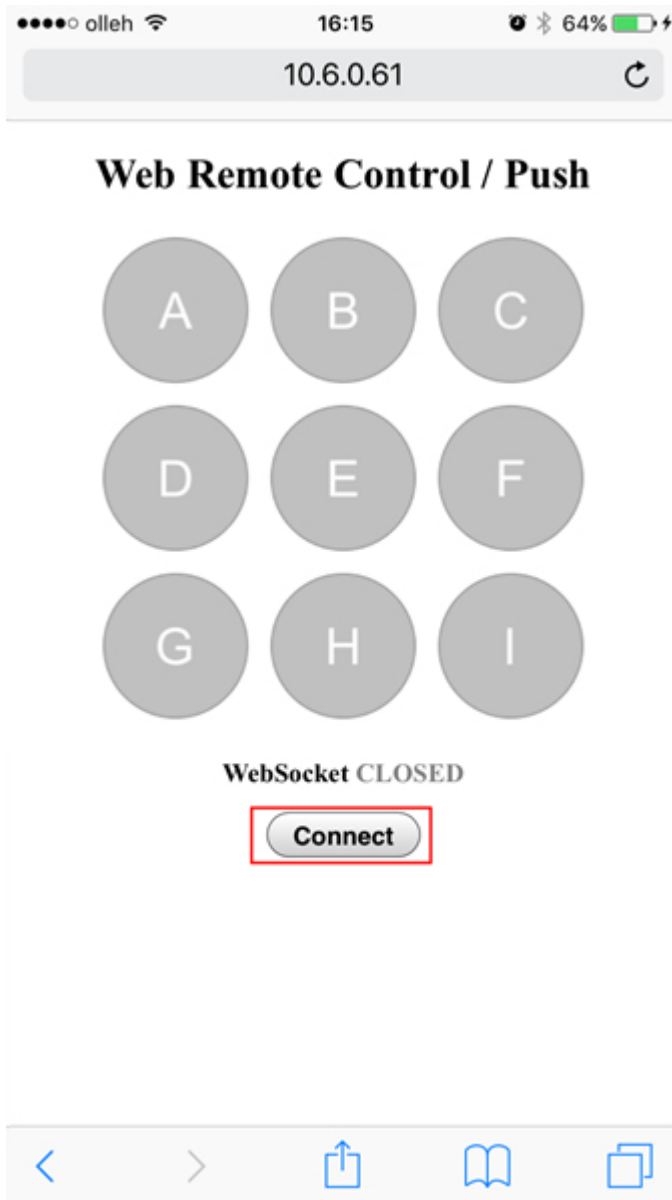

11. After the connection, check if the status of the A, B, and C buttons are appeared on the serial monitor of Arduino IDE. (release state)

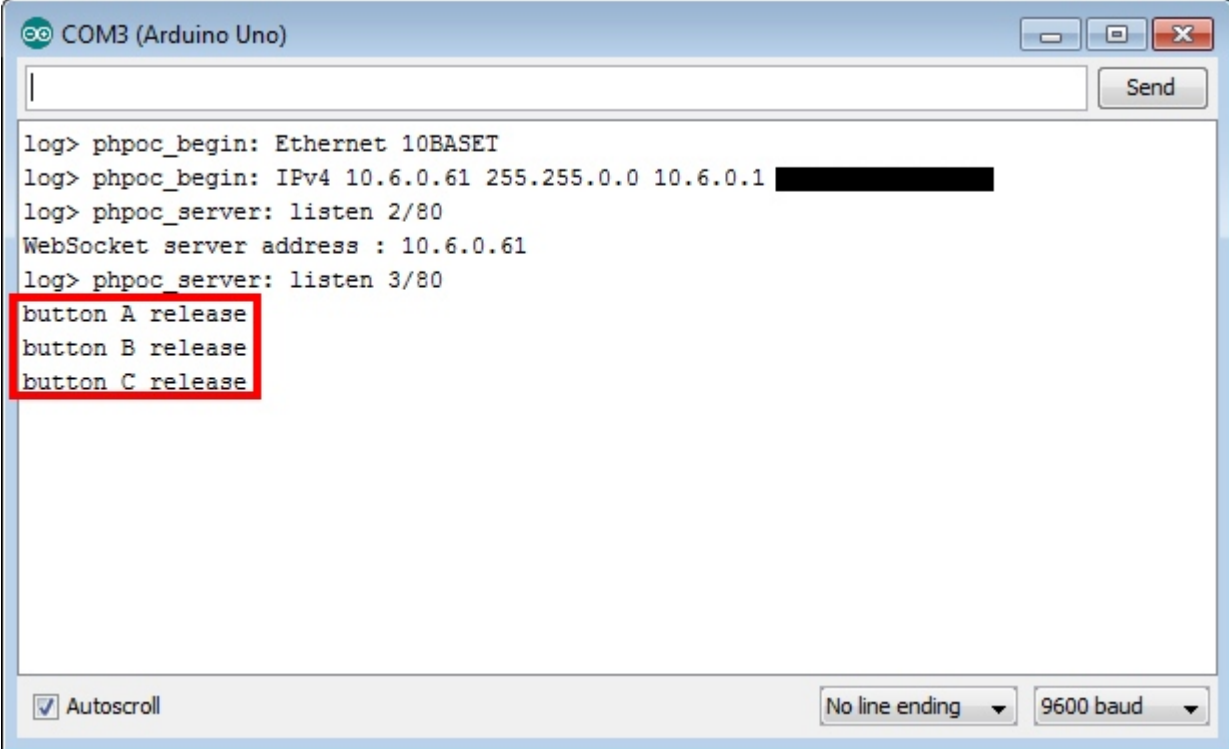

The screenshot shows the serial monitor window for COM3 (Arduino Uno). The window title is "COM3 (Arduino Uno)". The output text is as follows:

```
log> phpoc_begin: Ethernet 10BASET
log> phpoc_begin: IPv4 10.6.0.61 255.255.0.0 10.6.0.1 ██████████
log> phpoc_server: listen 2/80
WebSocket server address : 10.6.0.61
log> phpoc_server: listen 3/80
button A release
button B release
button C release
```

The last three lines of output, "button A release", "button B release", and "button C release", are enclosed in a red rectangular box. At the bottom of the window, there is a checkbox for "Autoscroll" which is checked, and two dropdown menus for "No line ending" and "9600 baud".

12. Press button 'A' two times from the web.

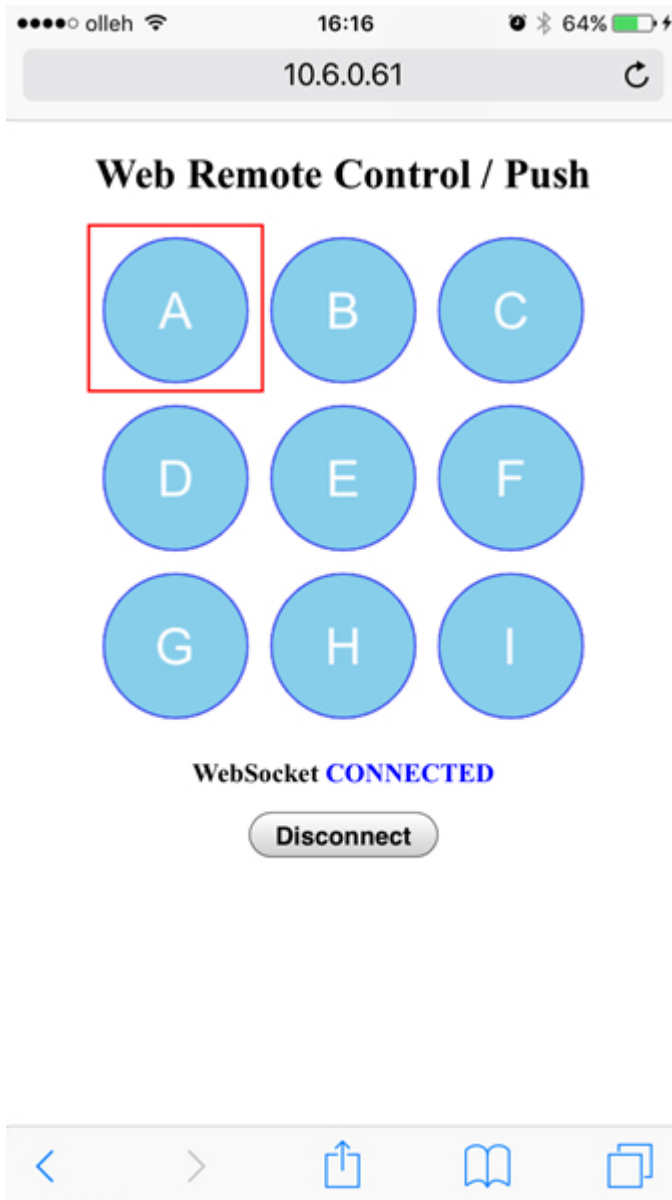

13. Verify the state of button 'A' is updated on the Arduino Serial Monitor IDE.

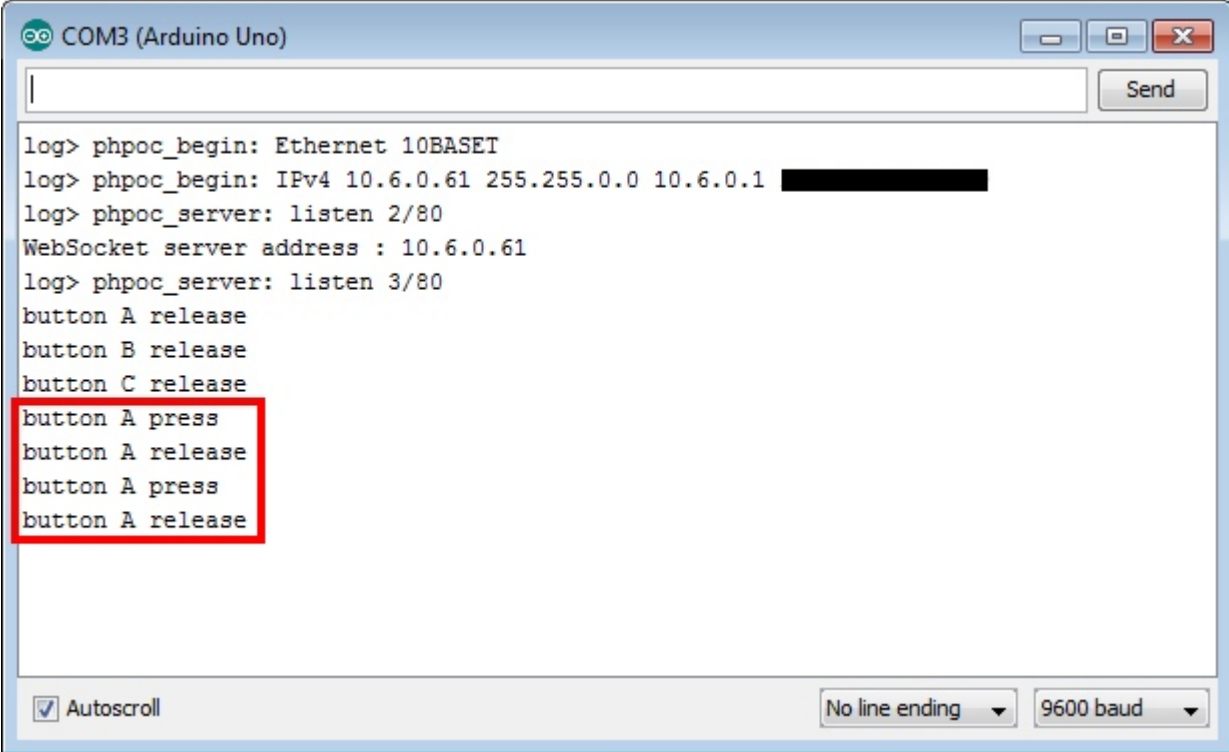

```
log> phpoc_begin: Ethernet 10BASET
log> phpoc_begin: IPv4 10.6.0.61 255.255.0.0 10.6.0.1 [REDACTED]
log> phpoc_server: listen 2/80
WebSocket server address : 10.6.0.61
log> phpoc_server: listen 3/80
button A release
button B release
button C release
button A press
button A release
button A press
button A release
```

This example only processes for these three buttons (A, B, C). Add the rest of buttons to Arduino codes yourself.

Web Remote Control (Slide)

We can control Arduino remotely by using the web remote control and sending Arduino specific data on the web. PHPoC Shield for Arduino provides the ability to send continuous data to the Arduino using a lever on the Web.

After finishing the steps below, try modifying this example to control LED, motor or other devices.

Using Web Remote Control (Slide)

1. Connect the shield to the network according to [Connecting to Network](#).
2. Install Phpoc Library to your PC according to [Installing The Library](#).
3. Run the Arduino IDE from the PC.



4. Open the "WebRemoteSlide" example.

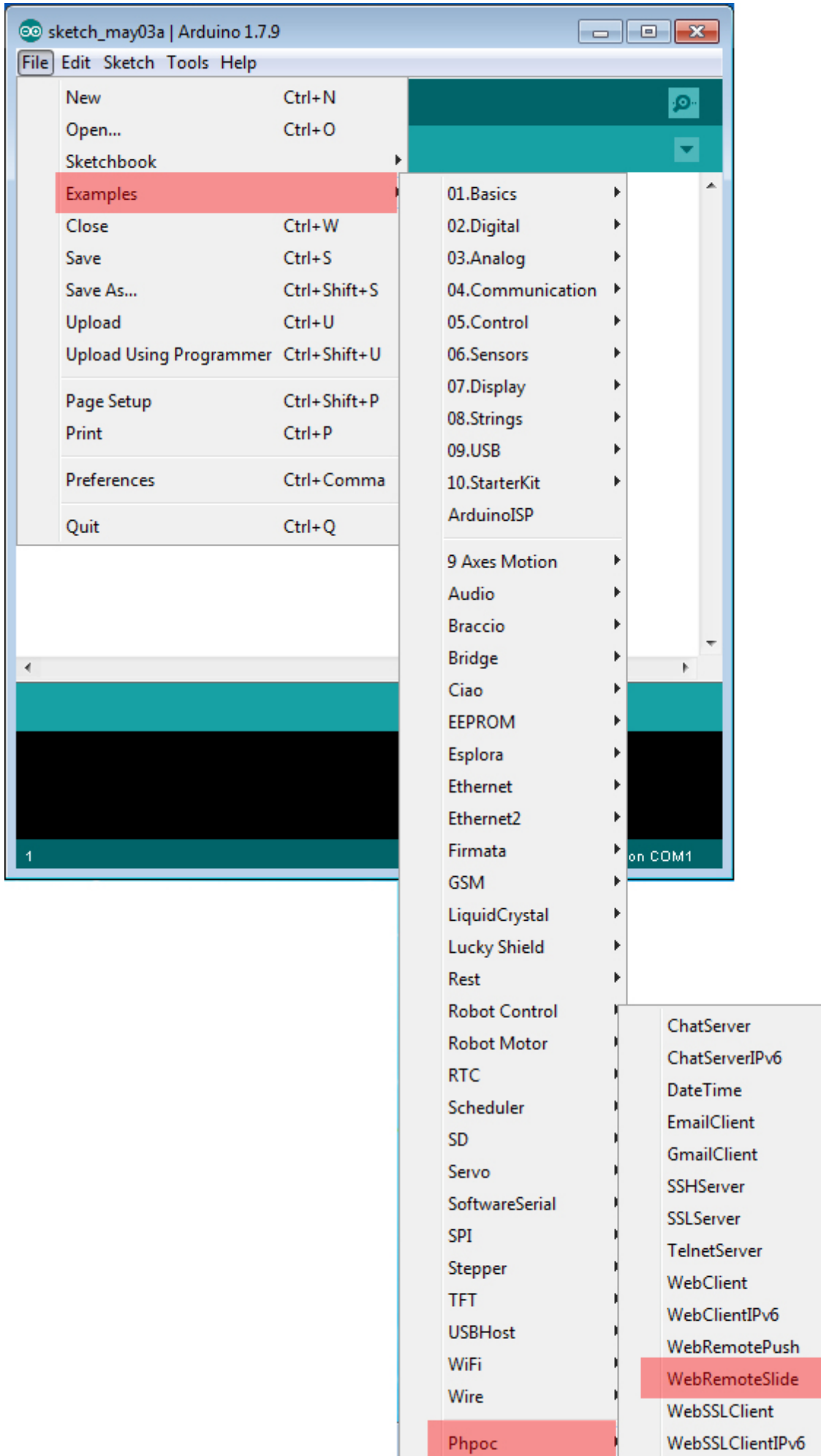

5. After checking the example, upload it to the Arduino.

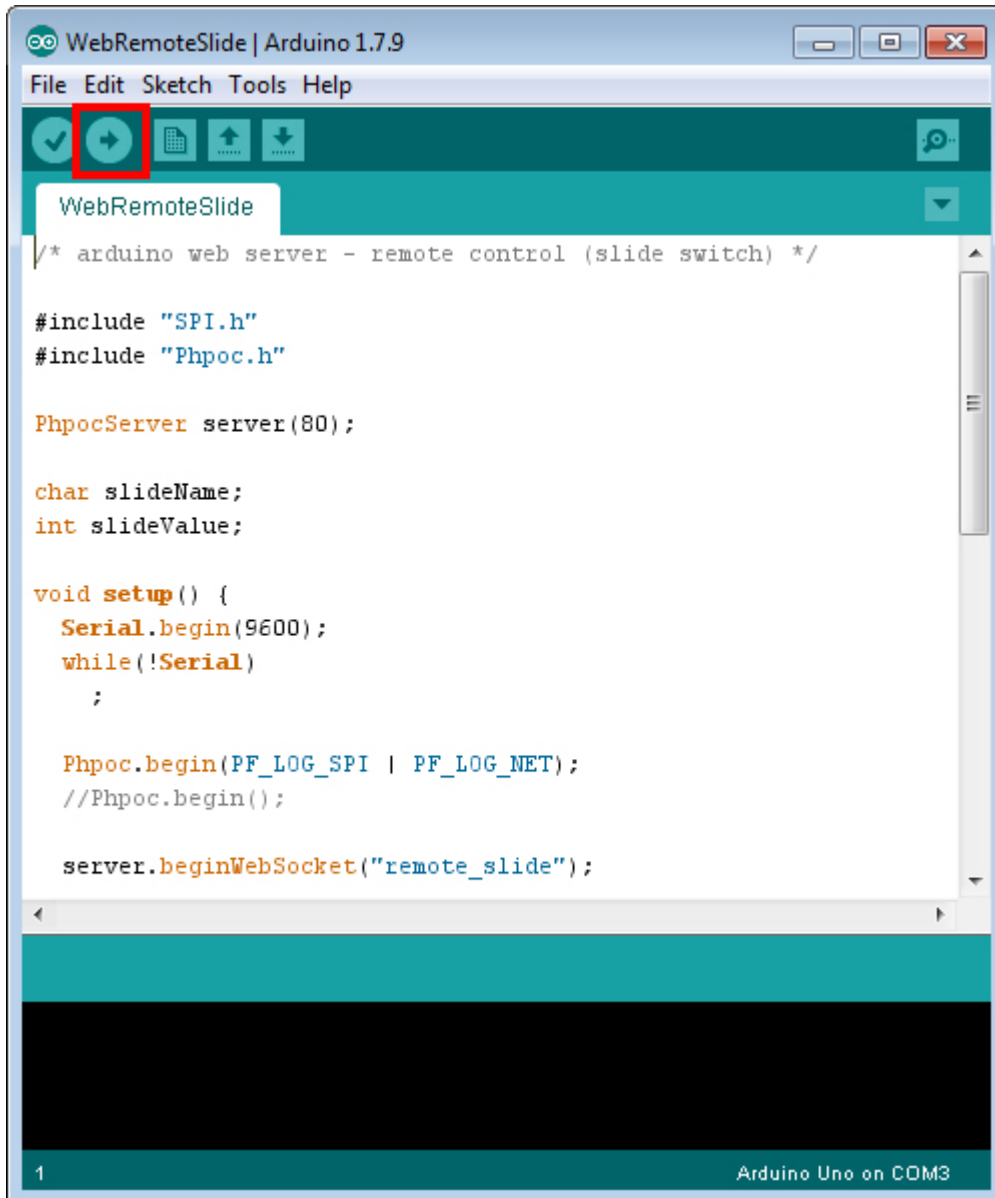

6. Click the serial monitor of the Arduino IDE.

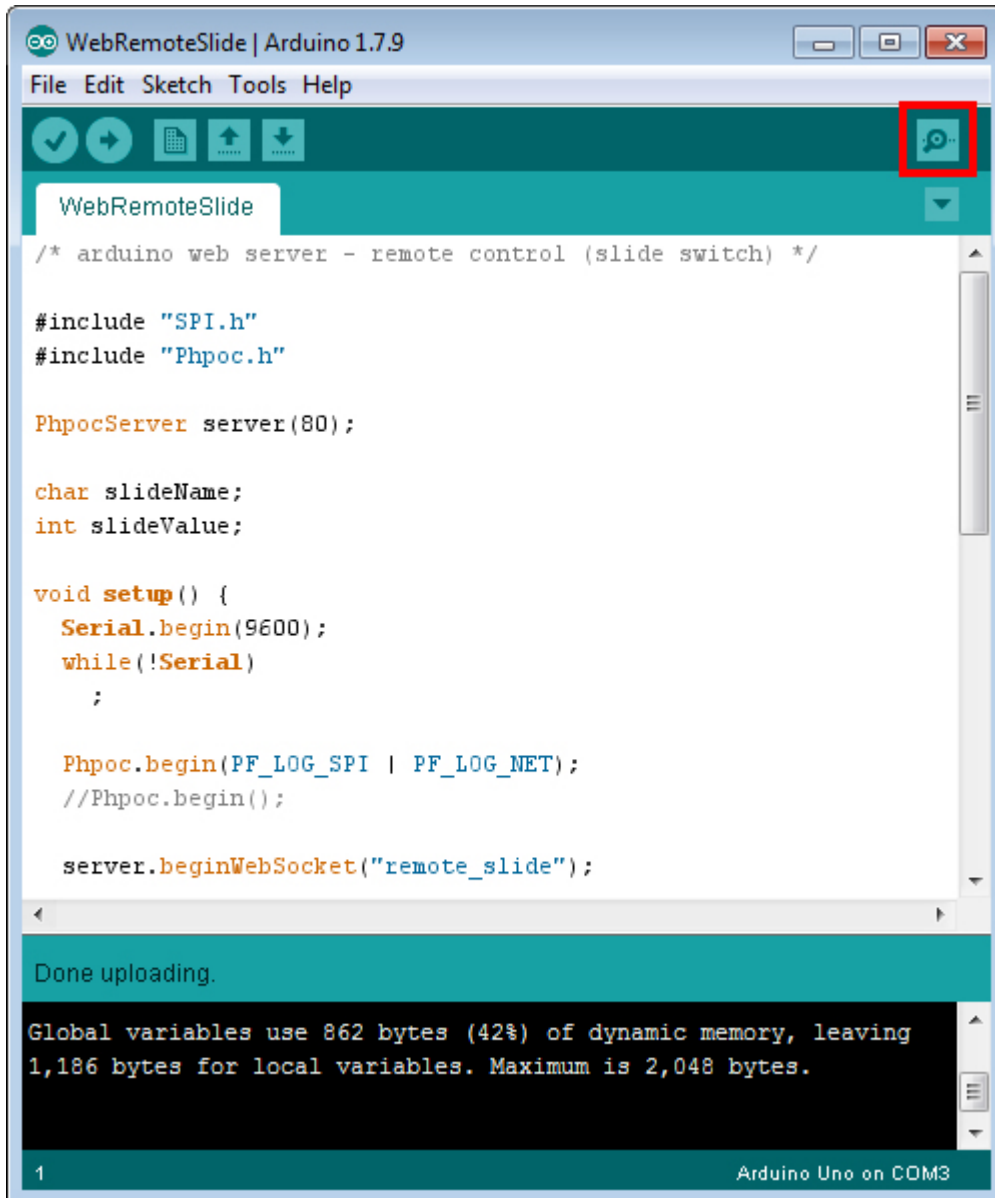

7. Check the IP address of the shield and leave the window open.

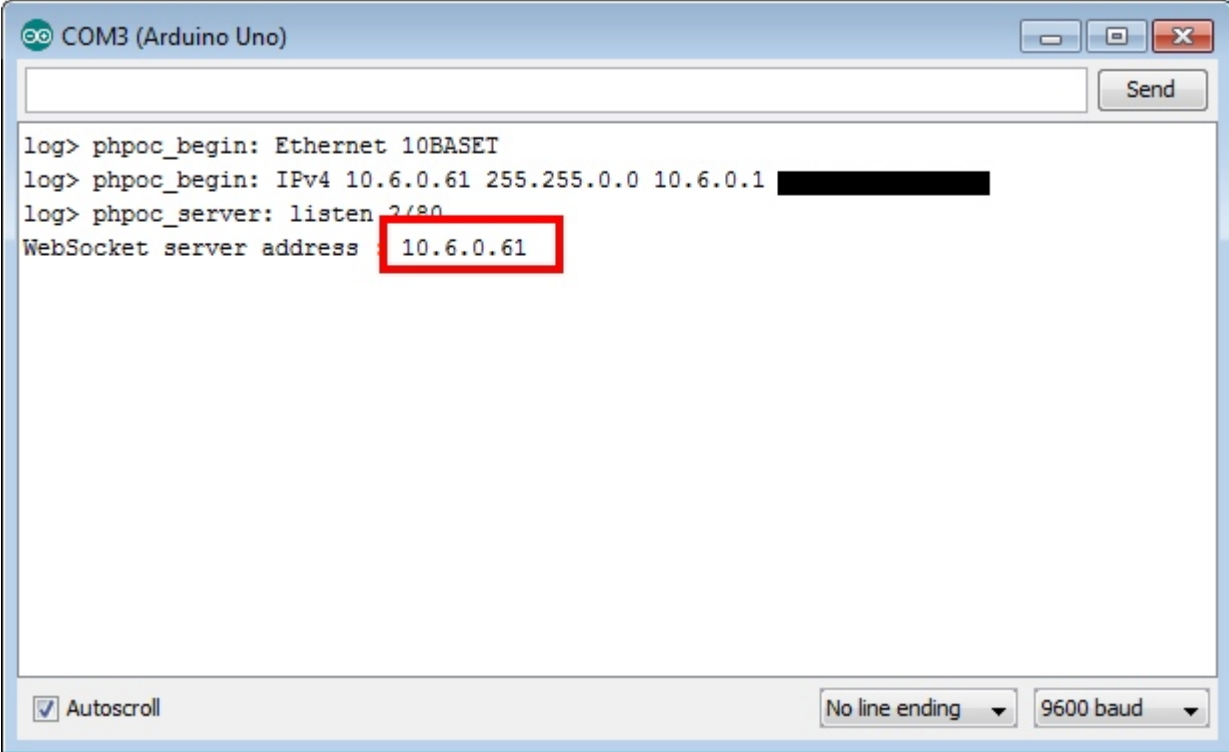

```
log> phpoc_begin: Ethernet 10BASET
log> phpoc_begin: IPv4 10.6.0.61 255.255.0.0 10.6.0.1 ██████████
log> phpoc_server: listen 2/80
WebSocket server address : 10.6.0.61
```

8. Now run a web browser on your smartphone or PC and connect to the IP address of the shield.



9. Click "Web Remote Control / Slide" link.



10. Click "Connect" to connect to the shield.

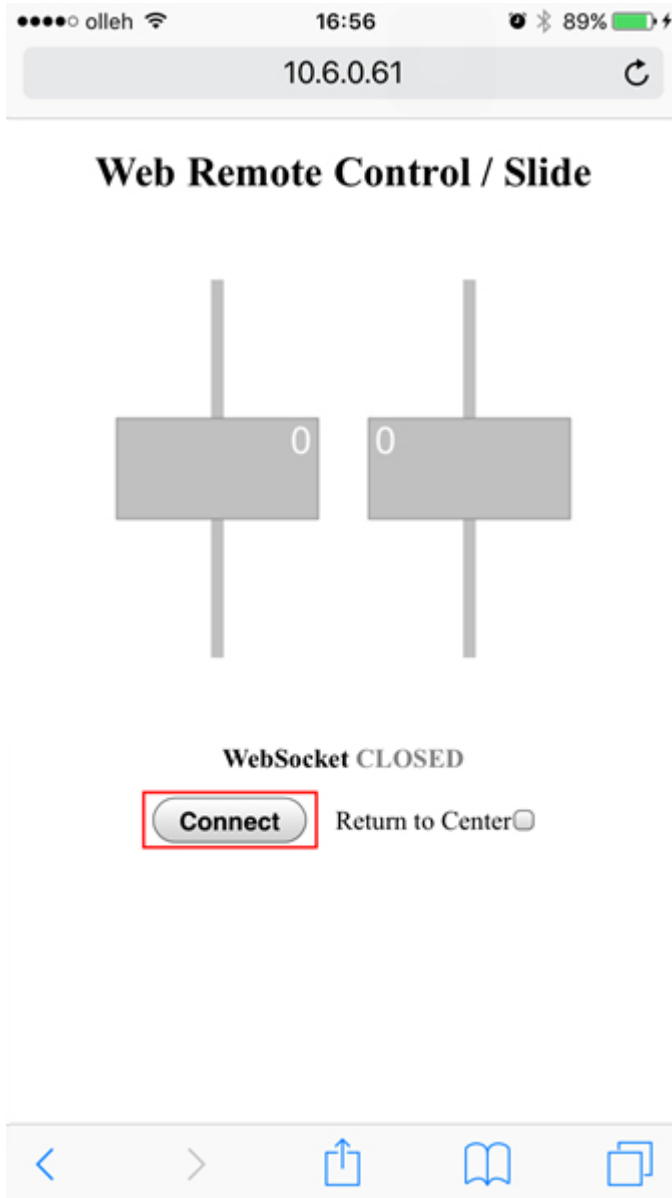

11. Pull the left lever up on the web.



Web Remote Control / Slide

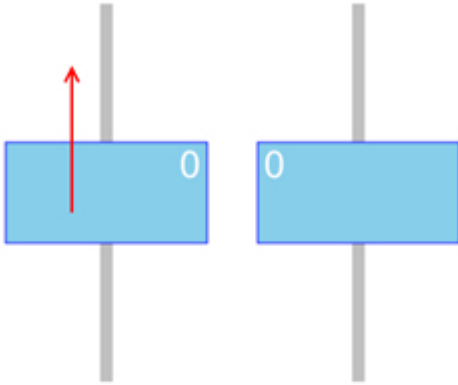

WebSocket **CONNECTED**

Disconnect

Return to Center



12. Ensure that the data of the 'A' lever is properly updated on the Serial Monitor of Arduino IDE.

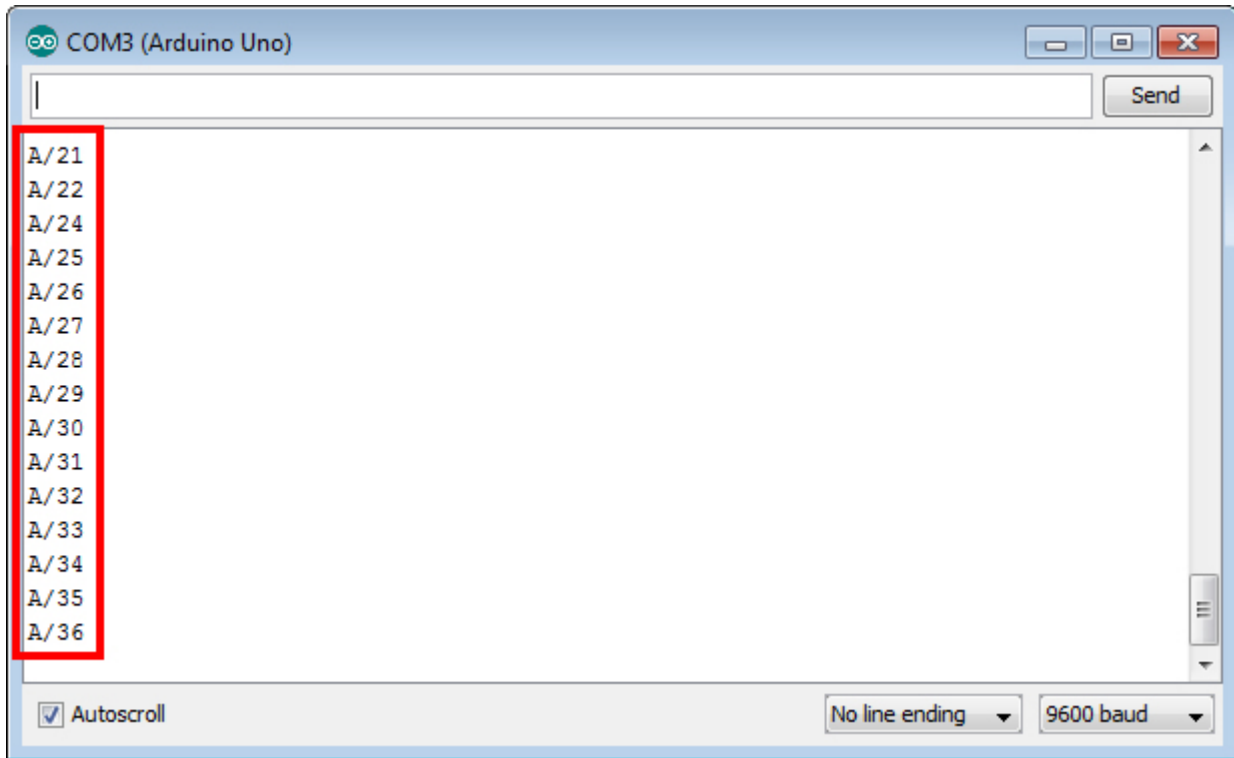

Setting the Time

PHPoC Shield for Arduino provides an RTC function for time information. With the built-in battery mounted on the shield, it maintains the time information even when the power is turned off. Therefore, time setting requires only once.

Because of the built-in battery charging system, the battery is charged whenever the power is connected to the shield. However, if you do not connect power to shield for a long period (about 30 days), the battery is discharged and time information may be initialized.

Setting the Time

1. Connect the shield to the Network, following the instructions from [Connecting to Network](#).
2. Connect SETUP page of the built-in web server of the product with your smartphone or PC.

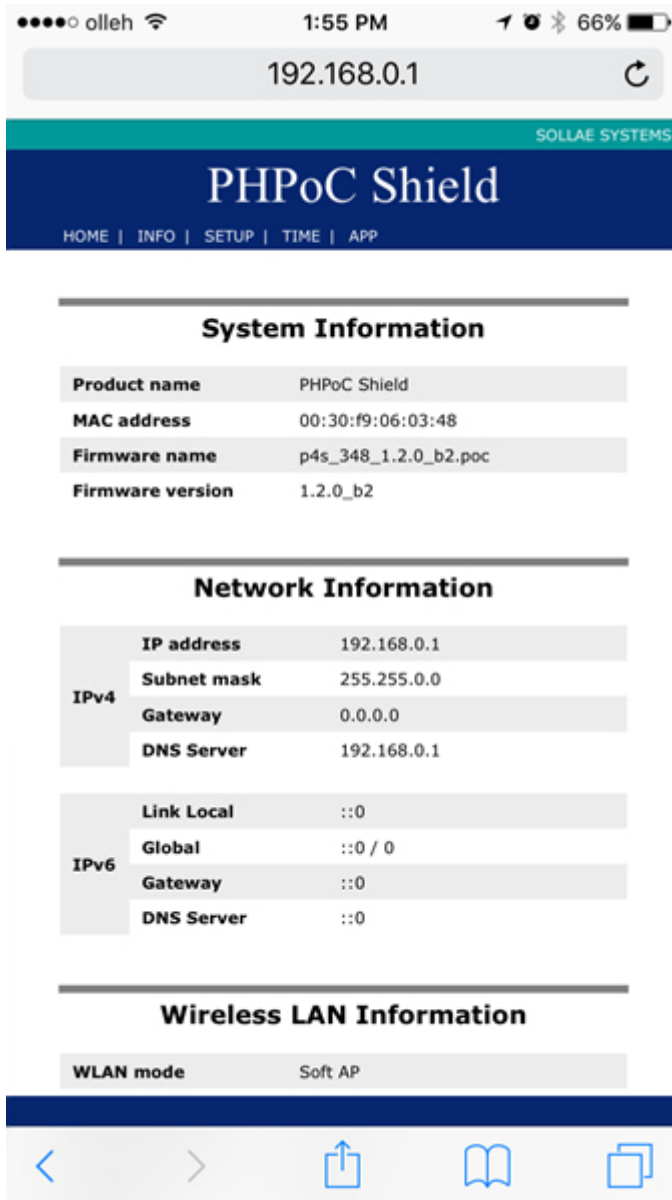

3. Click "TIME".

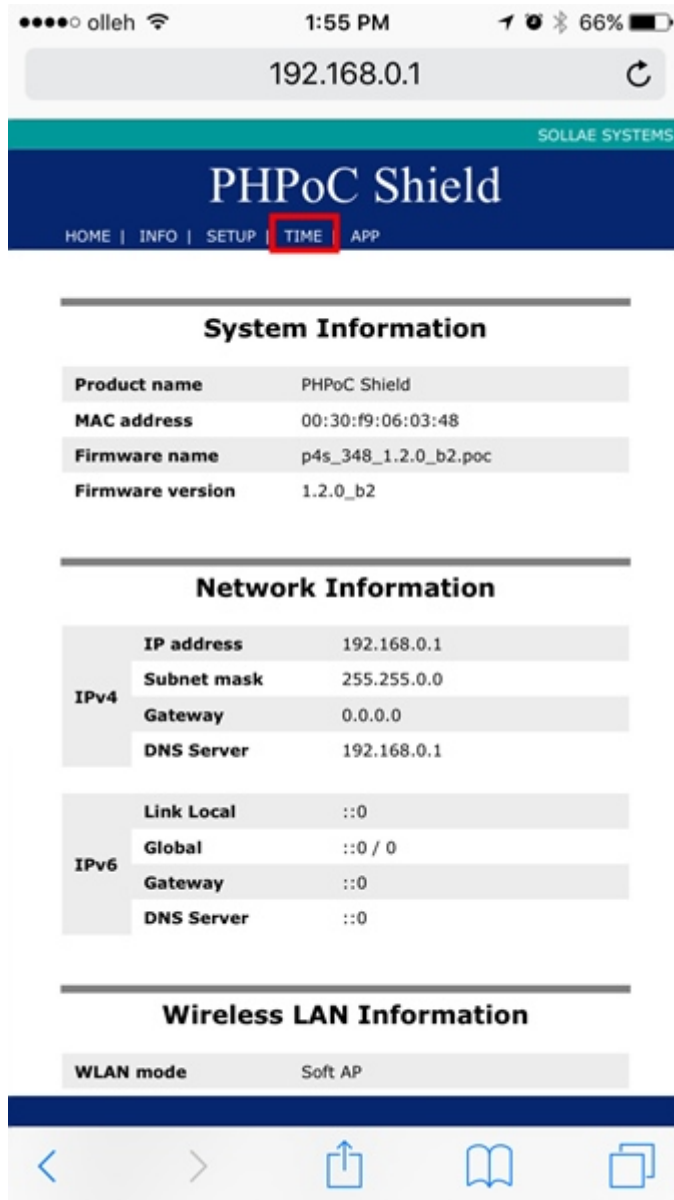

- Click "TIME SYNC" to synchronize the current time of the shield with your smartphone or PC.

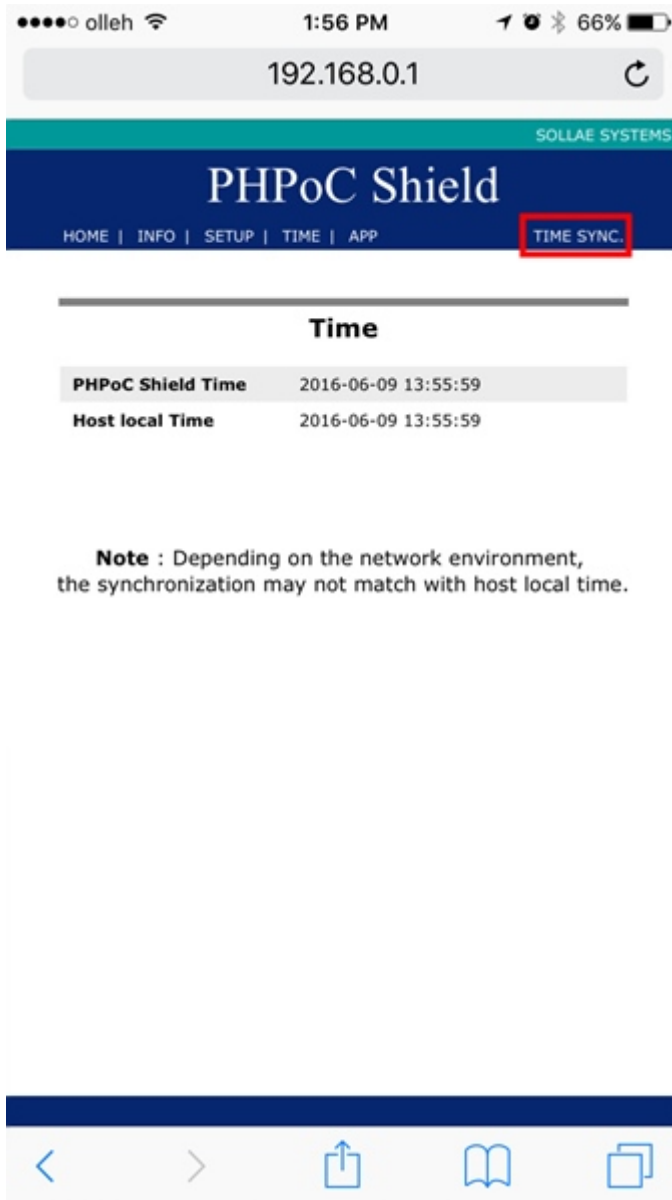

5. Make sure that the current time and the time on your smartphone or PC is synchronized with the shield.

